

Ignite adventure, Inspire imagination,



Play!

CATALOGUE



WELCOME TO OUR CATALOGUE

SHOWCASING Playground Designs for Schools!



PREFERENCES

Customise your playground

PARK SUPPLIES & PLAYGROUNDS

A playground design, manufacturing, installation and maintenance specialist. We strive to make playgrounds that ignite adventure, inspire imagination, and create joy and excitement in children through play.



- Design and manufacture our equipment in New Zealand.
- Design and build playgrounds that give your children a play experience that inspires learning, imagination, adventure and joy.
- Make fully customisable playgrounds designed specifically for your community.
- Design and build playgrounds that aid children in their physical development, fitness and growth.
- Project Manage your playground development from start to finish.
- Offer full parts, repair, maintenance and after install care service.
- Making playgrounds in New Zealand for over 30 years.



OUR PROCESS - WORKING WITH US

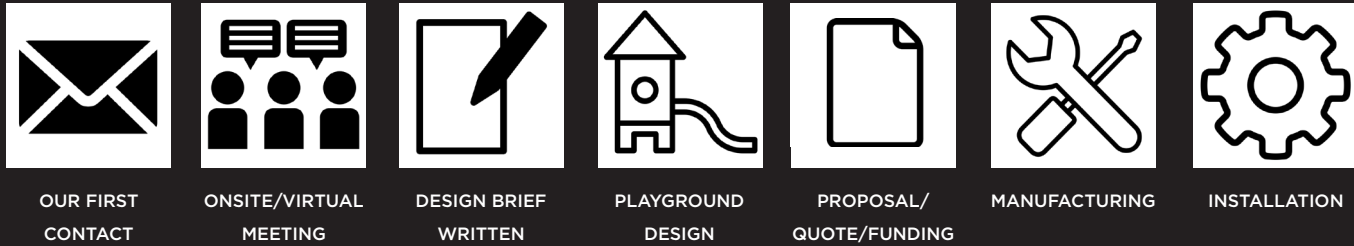

Your dream to reality - A brand new playground!

CUSTOM PLAYGROUND DESIGN

Our design team can work with you to create your own custom playground at your school, through our free 3D CAD service. Using your choice of equipment and plans of your site we can work out the most efficient, challenging and exciting playground.

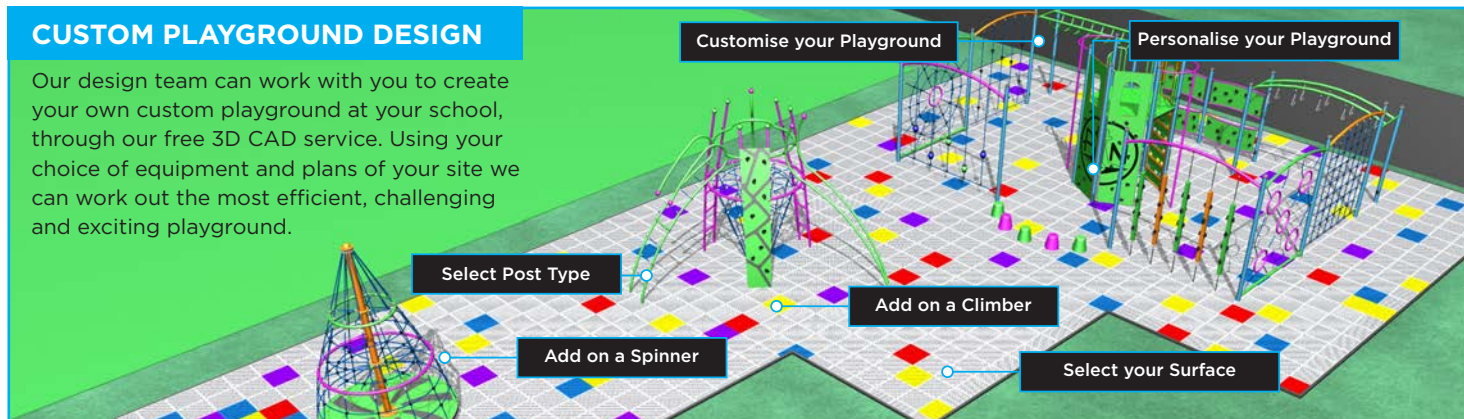

COLOUR OPTIONS



We have many colour options available, or choose from our colour configurations.

BUBBLE GUM 	SUMMER 	HERITAGE 	BOUNCE
MARINE 	FOREST 	NATURE 	SPARK
BUMBLE BEE 	JAZZ 	WILD 	SPLASH

CUSTOM ROUTERING & POLYPLAY PANELS

PolyPlay is a unique material exclusive to Park Supplies & Playgrounds that allows us to fully personalise your playground. Our in-house design team can take your logo, motif, important words or sketches and convert these to CNC engraving onto the panels of your playground. We can customise rockwalls, panels, carousels, fitness trails or any panel item.

COLOUR OPTIONS

PolyPlay is available in three colour choices Lime Green, Sky Blue and Nature Green.

LIME GREEN



SKY BLUE



NATURE GREEN



CUSTOM ROUTERING

Park Supplies & Playgrounds offers a unique custom routing service, which means your playground can be fully customised for your school at very little additional cost.

Durability

- Unique 12mm thick co-extruded polyethelene, will not delaminate.
- UV stabilised, protection against fading.
- Graffiti resistant, impregnable material for ink.
- Tough, durable and long life.
- Made in New Zealand for NZ conditions.

Recyclable

- Polyplay material can be 'end of life' recycled.
- All waste and off cuts are recycled to make new boards.



SURFACE OPTIONS

There are many surfacing options available for your project. Some are listed below.

MOST POPULAR



WOODCHIP

Loosefill is a great surface for falls up to 3 metres. We construct timber edgings and install a certified woodchip that has a longer life span than bark. We can construct a timber edging and supply and install the certified woodchip.



WET POUR GRANULE RUBBER

Wet Pour Rubber provides a unique finish to your new playground. Combining multiple colours, curves and shapes to create a visually dynamic surface.

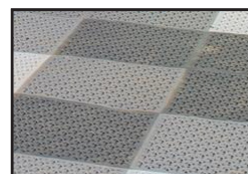

RUBBER MATTING TILES

Rubber Matting Tiles provide a great aesthetic finish to your new playground. We have many options available. Tiles can add a layer of security, with individual tiles being replaceable should vandalism occur.



SYNTHETIC TURF

Synthetic Turf provides a great grass look to your new playground. There are various grass pile height options to choose from.



SELECTING A PLAYGROUND DESIGN

PLAYGROUNDS ARE IMPORTANT!

When children explore playgrounds, they are building important life skills that will eventually help them become effective thinkers, leaders and collaborators.

Creating an environment where children can experience unstructured play supports their physical health and increases their chances of success in the classroom. Playtime can also have a calming effect, helping with disciplinary issues and impulse control.

AND of course it should be a place where they can have FUN!

WHAT TO LOOK FOR IN A WELL-BALANCED PLAYGROUND...

A well designed playground should offer physical, emotional, social and solitary play benefits for the children. A well-balanced playground should have a mix of elements to mentally and physically interest and develop the target age group of children.

THE PHYSICAL

Physically a playground should help develop important fine and gross motor skills. The features of a playground should build strength, flexibility, co-ordination and posture, as well as aiding the growth of healthy bones, joints and muscles.

A playground should contain activities that assist students to;

- Support their own body weight, including inverted positions
- Build grip strength through a wide variety of grips
- Strengthen their upper body and core
- Improve their agility, flexibility and fluidity of movement
- Improve focus, accuracy, problem-solving and mental acuity

THE SOCIAL

Free play is an essential tool for allowing children to develop a sense of who they are and to value the thoughts and feelings of others. All of the activities we design will help children to make subtle changes in their emotional wellbeing by developing self-confidence when experimenting with skill and challenge.

Our playgrounds make it is easier for children to create social connections through free play, teaching them how to interact and share with each other. However we also offer opportunities for solitary play. Providing solitary play will give children time to think, explore and create.

A RANGE OF PLAYGROUND FEATURES THAT CAN ACHIEVE THIS ARE;

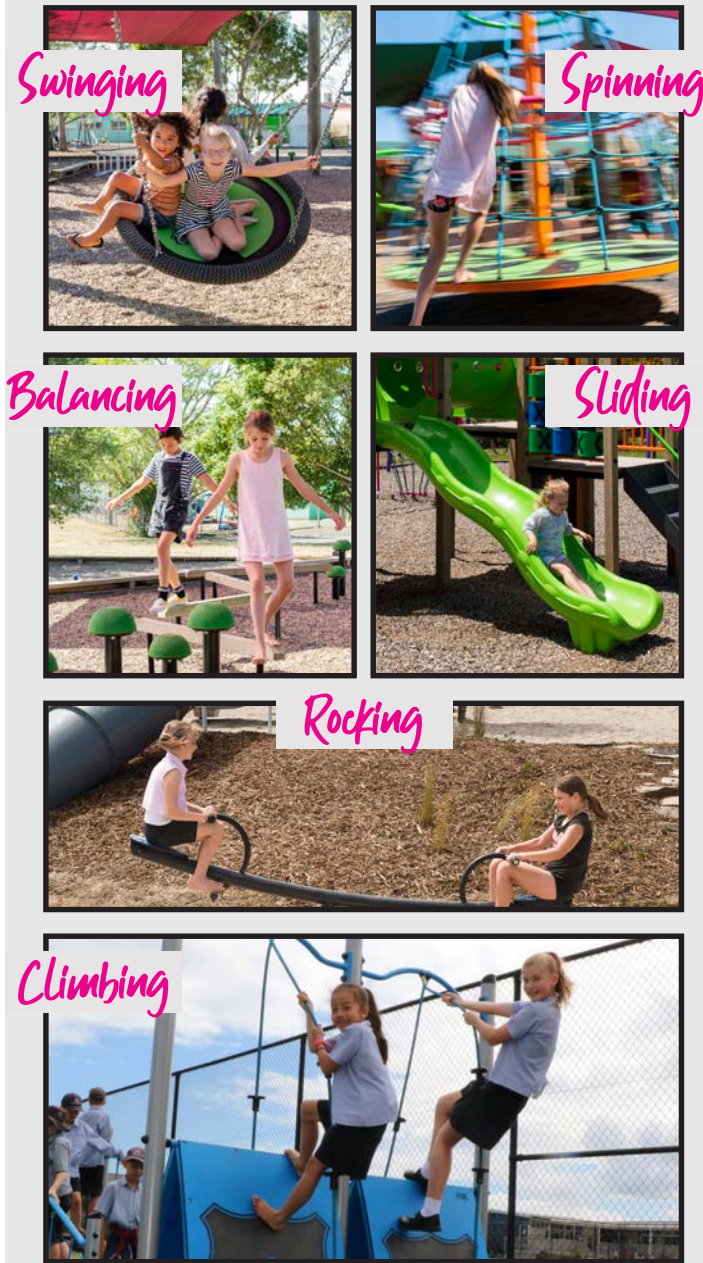

PLAYGROUND DESIGN CAN INCLUDE COLOURS AND FEATURES THAT IGNITE ADVENTURE, INSPIRE IMAGINATION AND CREATE JOY AND EXCITEMENT IN CHILDREN THROUGH PLAY.

A playground does not need to contain everything. Different playgrounds have different purposes depending some factors, such as the target age group and the type and style of other playgrounds nearby.

Ignite adventure, Inspire imagination, Play!



POST OPTIONS AND SHADE

We have two post options available for your new playground, both with unique features.

TIMBER POST

Park Supplies & Playgrounds uses H5 Pine Timber (90 x 90mm). This is our post of choice as it adds a great natural contrast to the overall play equipment, is tough and durable and also economical as a post material. Our posts are finished with rounded edges and are sanded smooth.

FEATURES

- Economical
- Contrasting Aesthetic
- Natural
- Durable



STEEL POST

We use a 90mm diameter round galvanised post with a very tough and durable coating system, which includes a baked layer of zinc shield ensuring thickness and adhesion. A final polyester colour layer is added with a colour of your choice. Steel posts are a premium option and cost more than timber posts.

FEATURES

- Highly Durable
- Colour Options
- Graffiti Resistant



Shade is an important playground design consideration. Park Supplies & Playgrounds can incorporate shade sails in your proposal and project manage the installation. Please let us know if you would like to include this in your design and quote.





FREE STANDING EQUIPMENT

Spinners

Our range of freestanding elements can be used on their own to create a small feature play area. They also make great additions to modernise any tired or existing play area. With small footprints and loads of fitness and agility features, these items pack a lot of play value.

KIDS LOVE MOTION!!!!

- DYNAMIC ELEMENTS IN PLAYGROUNDS TEACH CHILDREN ABOUT INERTIA, CENTRIFUGAL FORCE AND REACTION PHYSICS!



FREE STANDING EQUIPMENT

Spinners



Lunar FS414

Age Level: 5-15 yrs
Area Required: 5.6 x 5.6m
FHF: 1.0m
Physical Size: 2.4h x 1.6 x 1.6m



Minidome FS409

Age Level: 5-15 yrs
Area Required: 5.6 x 5.6m
FHF: 1.0m
Physical Size: 1.0h x 1.6 x 1.6m

Megadome FS410

Age Level: 5-15 yrs
Area Required: 6.3 x 6.3m
FHF: 1.0m
Physical Size: 1.0h x 2.3 x 2.3m

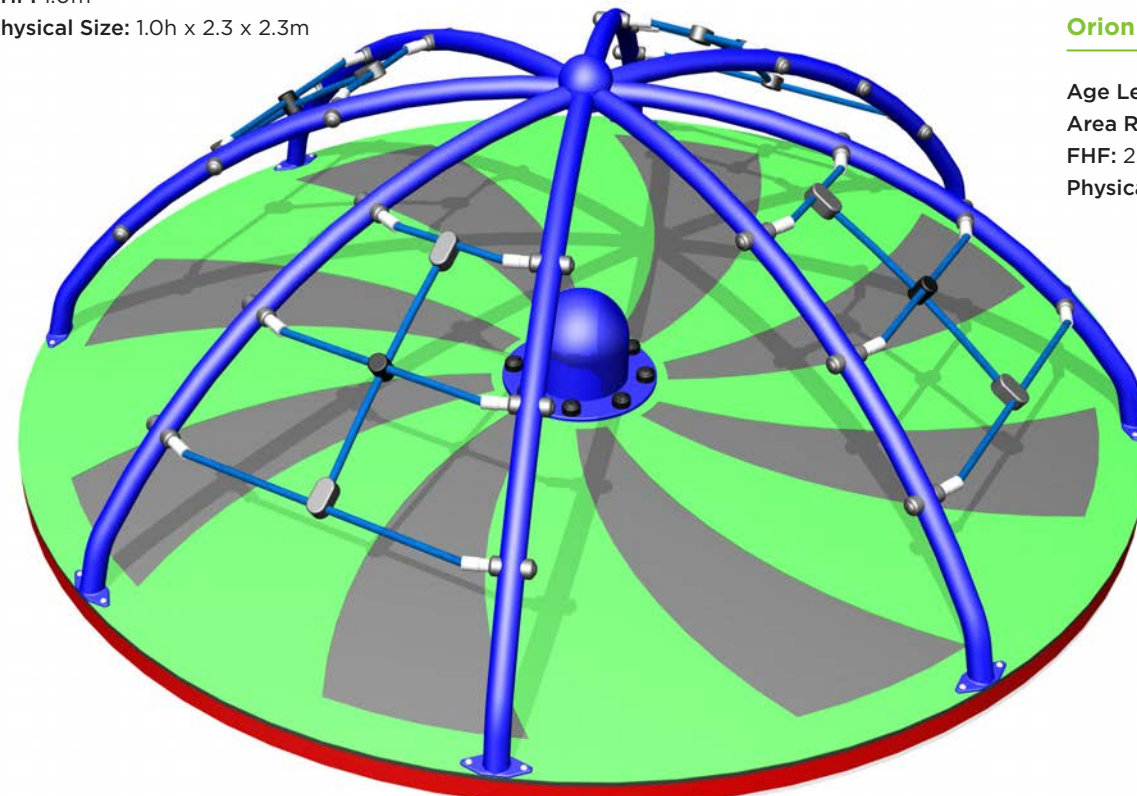

All inclusive access point makes it easy for children to join the fun

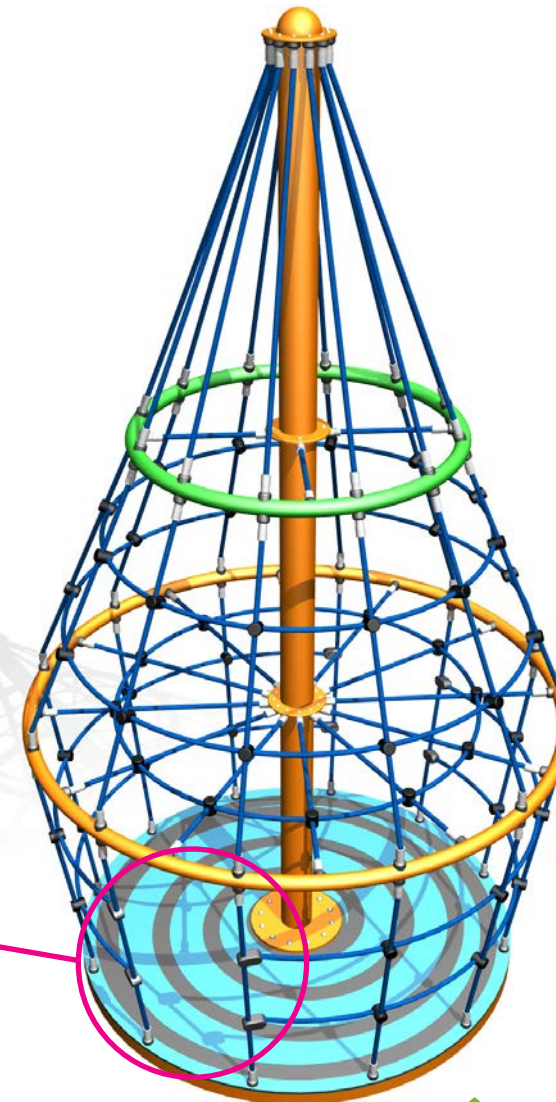

Orion FS408

Age Level: 5-15 yrs
Area Required: 6.1 x 6.1m
FHF: 2.4m
Physical Size: 3.6h x 1.9 x 1.9m



Orex FS415

Age Level: 5-12 yrs
Area Required: 6.5 x 6.5m
FHF: 2.4m
Physical Size: 3.6h x 2.3 x 2.3m



FREE STANDING EQUIPMENT

Curved Leg Swing

Lillypad Swing **CLS1LP**

Age Level: All Ages
 Area Required: 3.3 x 7.6m
 FHF: 1.4m
 Physical Size: 2.4h x 4.6 x 2.4m

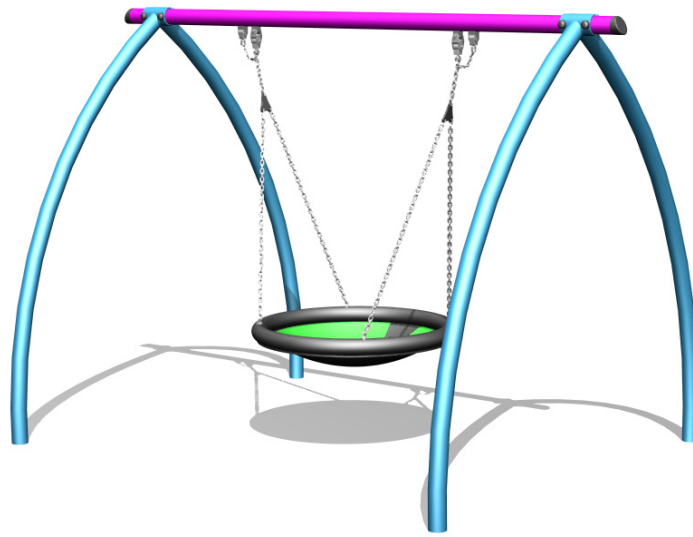

2 Bay Swing **CLS2D**

2x Belt Seats & 1x Lillypad
 Age Level: All Ages
 Area Required: 6.3 x 7.6m
 FHF: 1.4m
 Physical Size: 2.4h x 6.4 x 2.4m

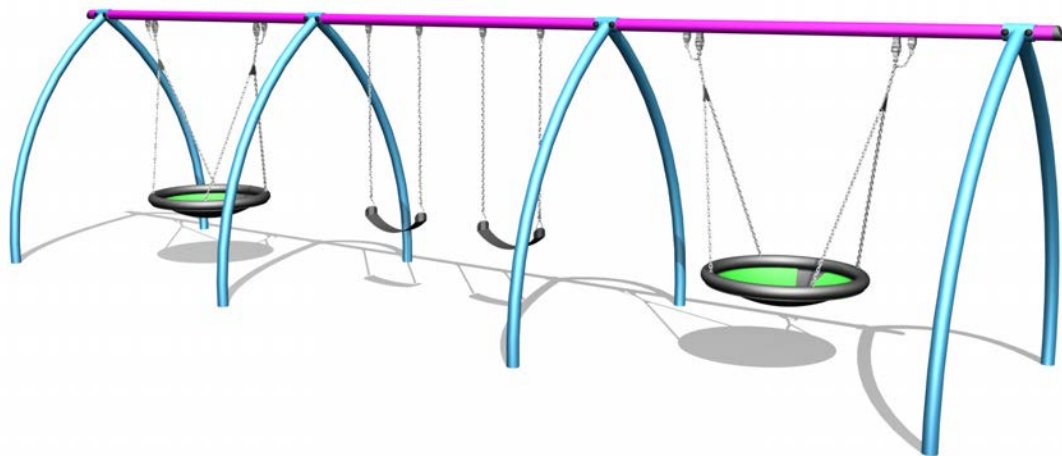
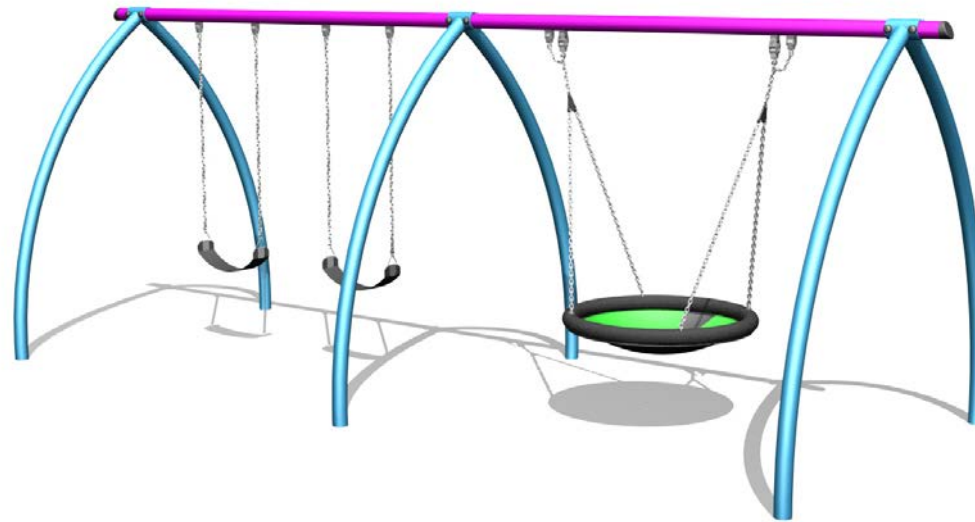

3 Bay Swing **CLS3D**

2x Belt Seats & 2x Lillypads
 Age Level: All Ages
 Area Required: 9.0 x 7.6m
 FHF: 1.4m
 Physical Size: 2.4h x 9.1 x 2.4m

THE LILLYPAD IS AN ALL AGE, ALL ABILITY INCLUSIVE SWING.

Everyone, from youngest to your oldest student can enjoy this swing.

The dish-shaped Lillypad is also perfect for children with disabilities as it supports their whole body and the rope edges give a secure grip.

The perimeter of the Lillypad dish is impact tested and certified.



See our website www.parksupplies.co.nz for our full range of swings and dynamic elements.

Ignite adventure, Inspire imagination, Play!



FREE STANDING EQUIPMENT

Timber Pole Swings

Timber - Lillypad Swing **TAS1LP**

Age Level: All Ages
 Area Required: 4.2 x 7.6m
 FHF: 1.4m
 Physical Size: 2.7h x 4.2 x 2.5m

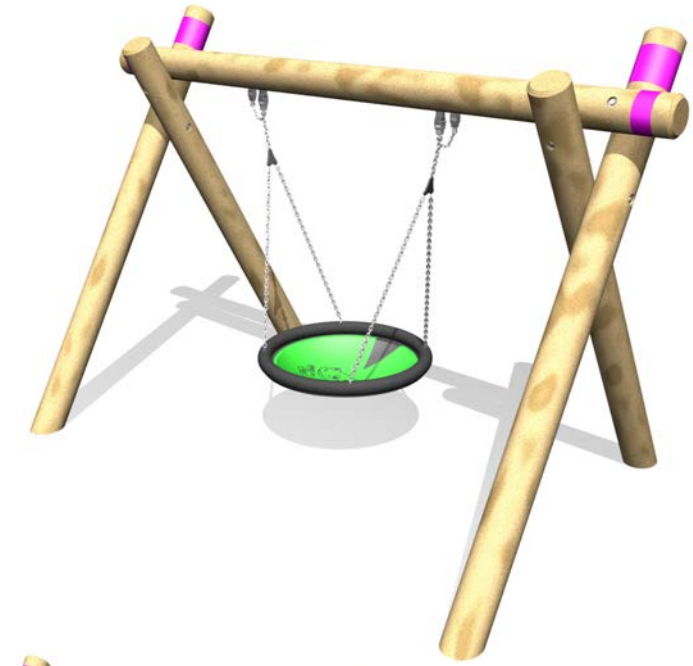

Timber - 2 Bay Swing **TAS2C**

Age Level: All Ages
 Area Required: 7.2 x 7.6m
 FHF: 1.4m
 Physical Size: 2.7h x 7.2 x 2.5m

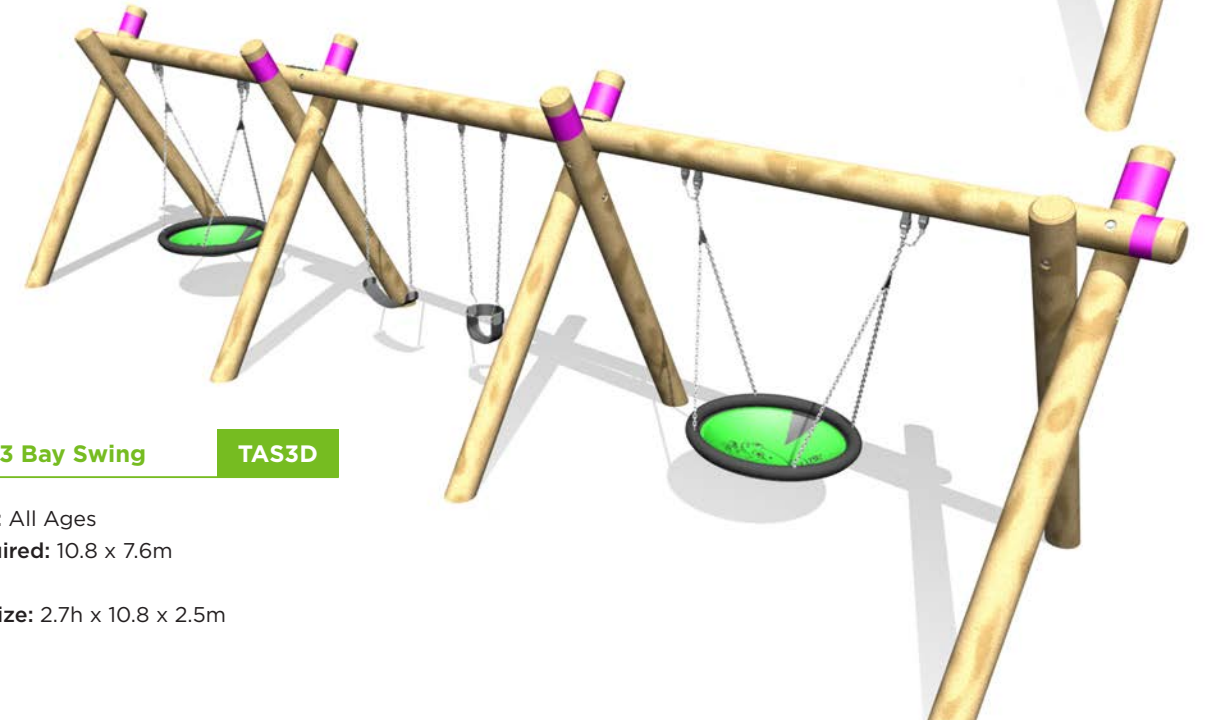
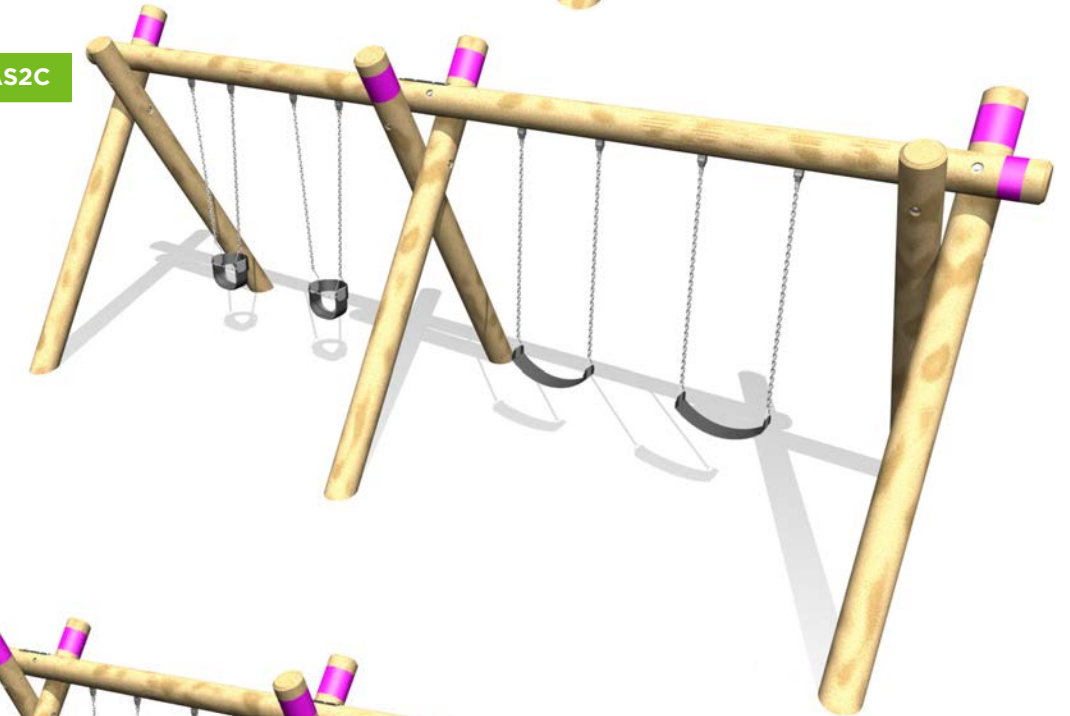

Timber - 3 Bay Swing **TAS3D**

Age Level: All Ages
 Area Required: 10.8 x 7.6m
 FHF: 1.4m
 Physical Size: 2.7h x 10.8 x 2.5m



FREE STANDING EQUIPMENT

Balance and Rope Climbers

Incorporating balance and rope climbers into your playgrounds helps children develop the skills and muscles to :

- Support their own body weight including inverted positions
- Build grip strength through a wide variety of grips
- Strengthen their upper body
- Improve their core strength
- Improve their connectivity, flexibility and fluidity of movement
- Become more agile
- Improve focus, accuracy, problem solving and mental acuity

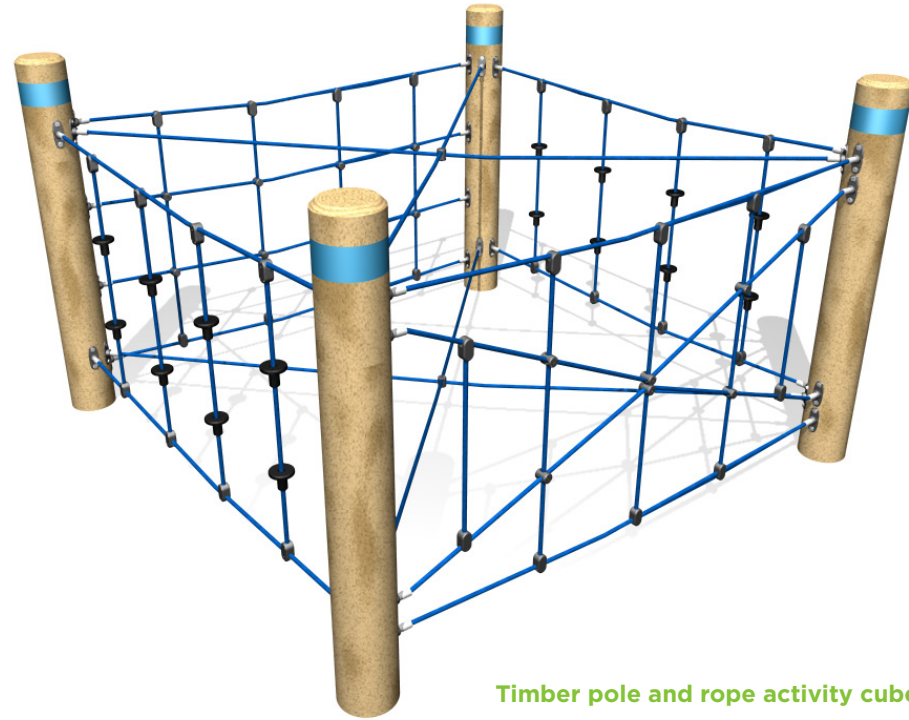

Timber pole and rope activity cube



Balance Toadstools

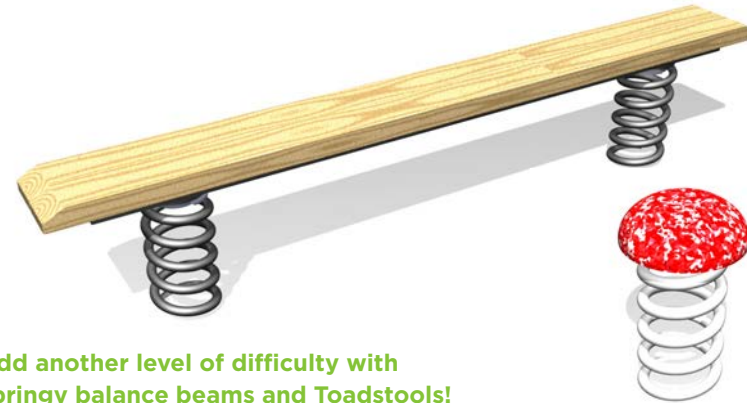

Add another level of difficulty with springy balance beams and Toadstools!



Combine balance beams, stepping logs, Toadstools and rope activities to create a sensory play area at your school

Ignite adventure, Inspire imagination, Play!



FREE STANDING EQUIPMENT

Rope Climbers



FS682



FS681



FS692

Boulder Climber

FS682

Rock Climber

FS681

Dragon Climber

FS684

Kaweka Climber

FS692



FS684

See our website www.parksupplies.co.nz for our full range of climbers

Zenith Climber

FS550

Age Level: All Ages

Area Required: 7.0 x 5.0m

FHF: 2.0m

Physical Size: 2.0h x 5.0 x 3.0m

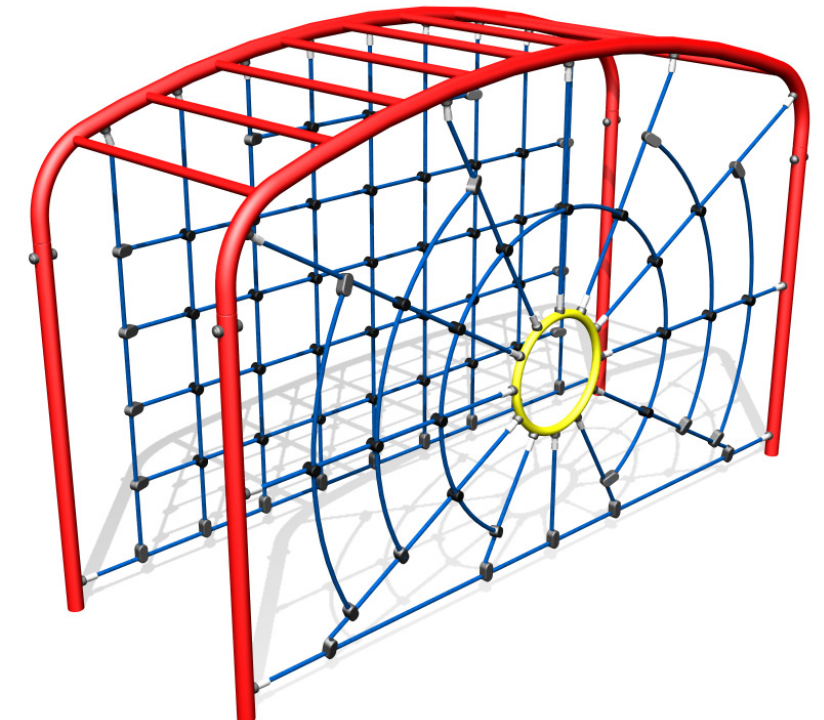



PARK PLAY & ACTIVITIES

Star, Kekewai

STAR

Star JP40

Age Level: 3-7 yrs
Area Required: 9.1 x 8.0m
FHF: 1.2m
Physical Size: 5.6 x 5.2m
Post: Timber or Steel

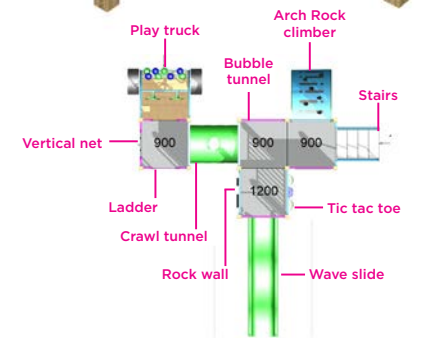

PARK PLAY & ACTIVITIES

Ponga, Twirler, Wave Rider, Junior Rocker, 4 Seat Seesaw

Ponga FS805

Age Level: 3-7 yrs
Area Required: 10.2 x 7.2m
FHF: 1.6m
Physical Size: 3.0 x 3.6m
Post: Timber or Steel

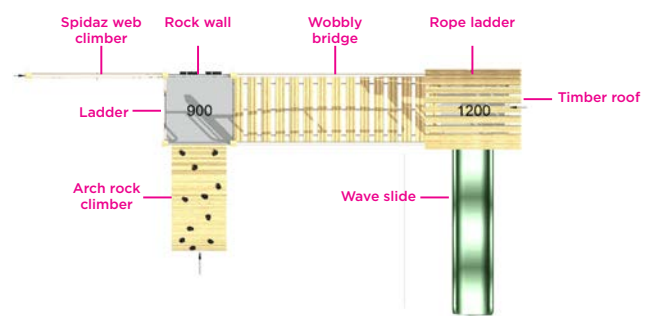

PONGA



KEKEWAI

Kekewai JP12

Age Level: 3-9 yrs
Area Required: 8.6 x 7.4m
FHF: 2.2m
Physical Size: 4.6 x 5.2m
Post: Timber or Steel

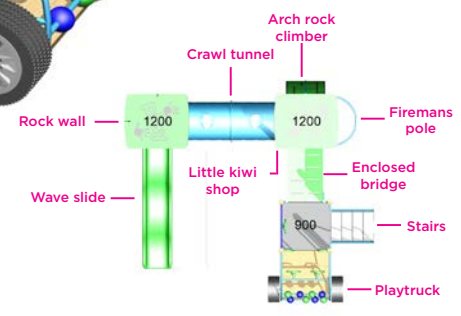

Twirler FS386

Area Required: 3.4 x 3.4m
Physical Size: 1.5h x 0.4 x 0.4m

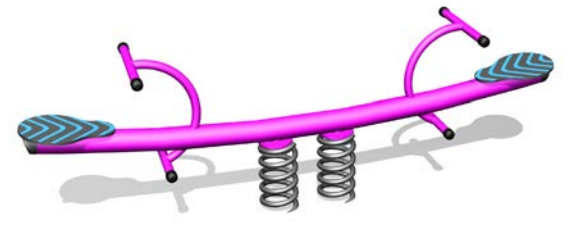

Wave Rider FS650

Area Required: 4.2 x 2.4m
Physical Size: 0.8h x 2.2 x 0.4m

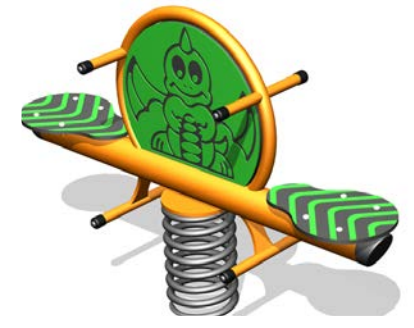

Junior Rocker FS625

Area Required: 3.2 x 2.4m
Physical Size: 0.85h x 1.2 x 0.3m
Also available in a marine theme

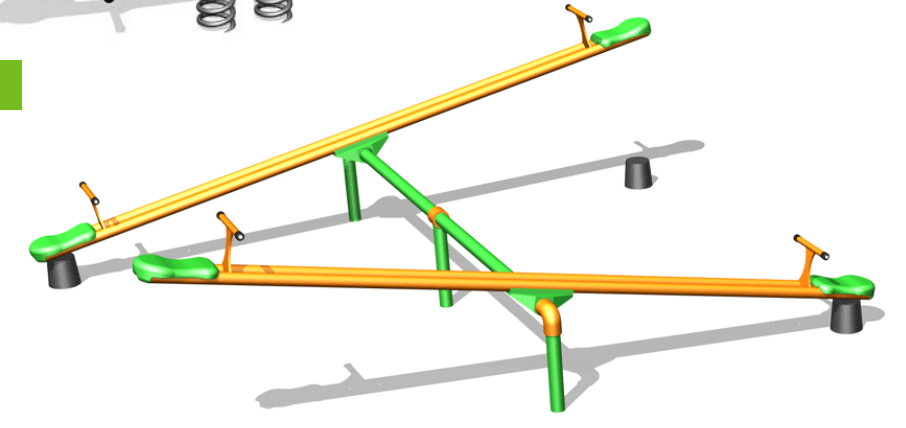

4 Seat Seesaw FS605

Area Required: 4.8 x 5.2m
Physical Size: 1.0h x 3.2 x 2.8m

NO CAR TYRES - COMPLETE WITH OUR WET POUR RUBBER BUFFER MOUNTS!



MUSIC PLAY HARMONY BELLS, COLOSSUS CHIMES, DAISY PETAL DRUM

A sample of our **Music Play** equipment. Enquire for more options...



MUSIC PLAY CAVATINA, DIATONIC TEMBOS, RAINBOW SAMBAS

A sample of our **Music Play** equipment. Enquire for more options...



HARMONY BELLS

Harmony Bells MP06



COLOSSUS CHIMES

Colossus Chimes MP04



DAISY PETAL DRUM

Daisy Petal Drum MP05

Cavatina

Cavatina MP01



Diatonic Tembos MP02

DIATONIC TEMBOS



Rainbow Sambas

Rainbow Sambas MP03





DISABILITY PLAY

LILLYPAD SWING & BASKET, INFANT DISABLED HIGH BACK SWING SEAT

Lillypad Swing CLS1LP

Age Level: All Ages
Area Required: 3.3 x 7.6m
FHF: 1.4m
Physical Size: 2.4h x 4.6 x 2.4m

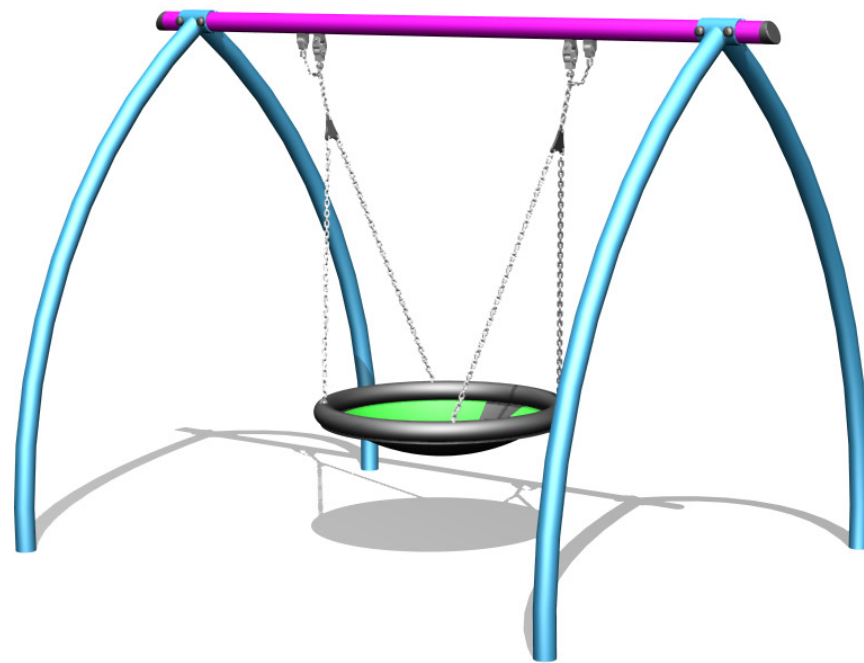

Lillypad Basket LPS

Lillypad Basket (Basket Only-
excl ropes & hangers)
Approx 1100mm diameter
6 user capacity and is fun for all ages.
Tested & certified to NZS:5828:2015
Graffiti Resistant and replaceable PolyPlay Base.

Infant Disabled High Back Swing Seat RP155ID

For children with mild to major disabilities.
Can be used in both commercial and residential applications.



Infant Disabled High Back Swing Seat INC100



DISABILITY PLAY

ORION SPINNER, JENN SWING, INCLUSIVE INTEGRATED CAROUSEL



All inclusive access point makes it easy for children to join the fun



Orion FS408

Age Level: 5-15 yrs
Area Required: 6.1 x 6.1m
FHF: 2.4m
Physical Size: 3.6h x 1.9 x 1.9m

Jenn Swing RP155JS

Full Body support swing for up to 55kg. Designed for children with physical and/or mental challenges.
Note: Please ask if the item is in stock when considering ordering as there is limited stock.



FS400 Inclusive Integrated Carousel

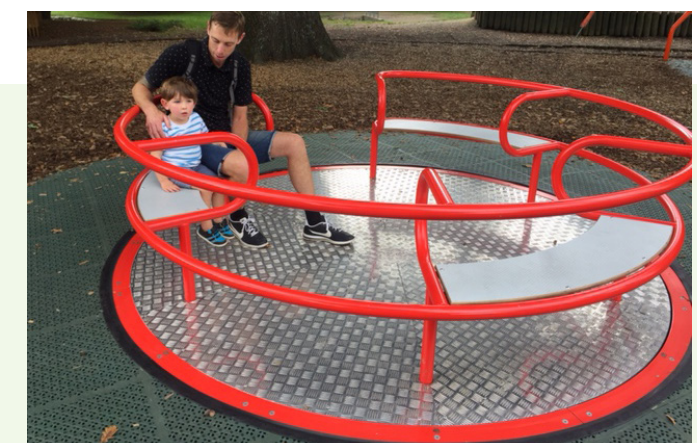



CUBE PLAY STRUCTURES

Jungle Cube, Climb N Cube and Mega Cube



CUBE PLAY STRUCTURES

Summit and Shute

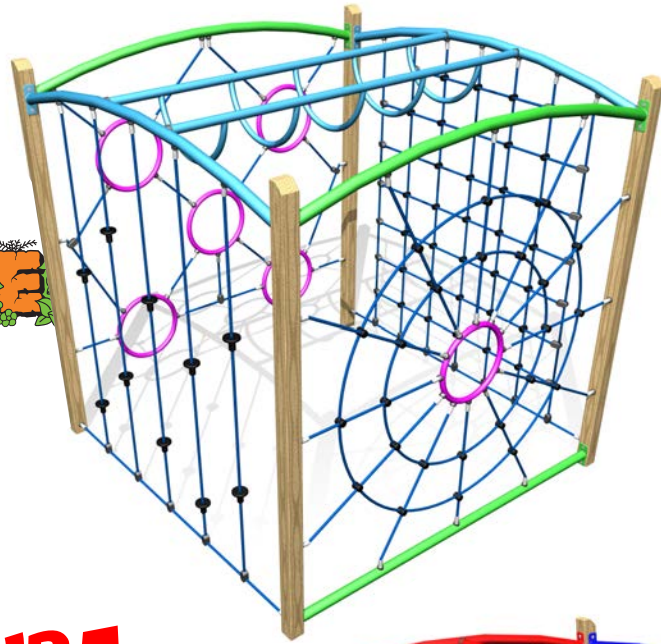

Jungle Cube FS417

Age Level: 7-15 yrs
Area Required: 7.2 x 7.2m
FHF: 2.7m
Physical Size: 2.7h x 2.6 x 2.6m
Post: Timber or Steel

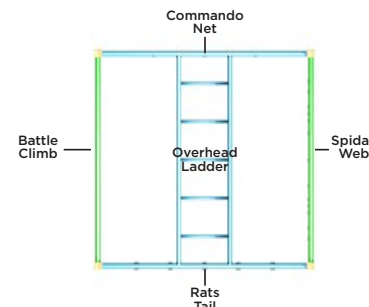

CLIMBNCUBE

Climb n Cube FS418

Age Level: 7-15 yrs
Area Required: 9.9 x 7.3m
FHF: 2.7m
Physical Size: 2.7h x 5.6 x 2.6m
Post: Timber or Steel

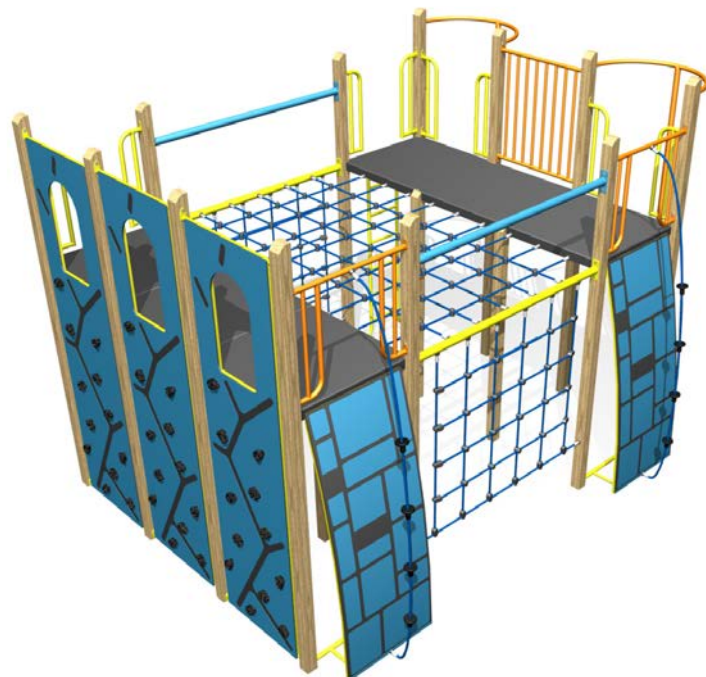
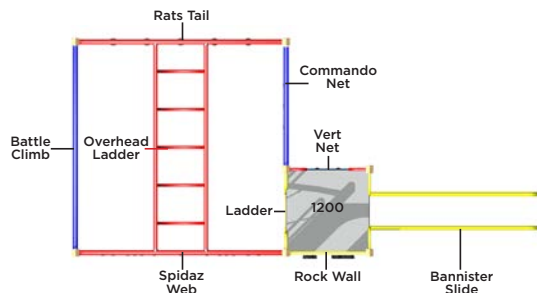
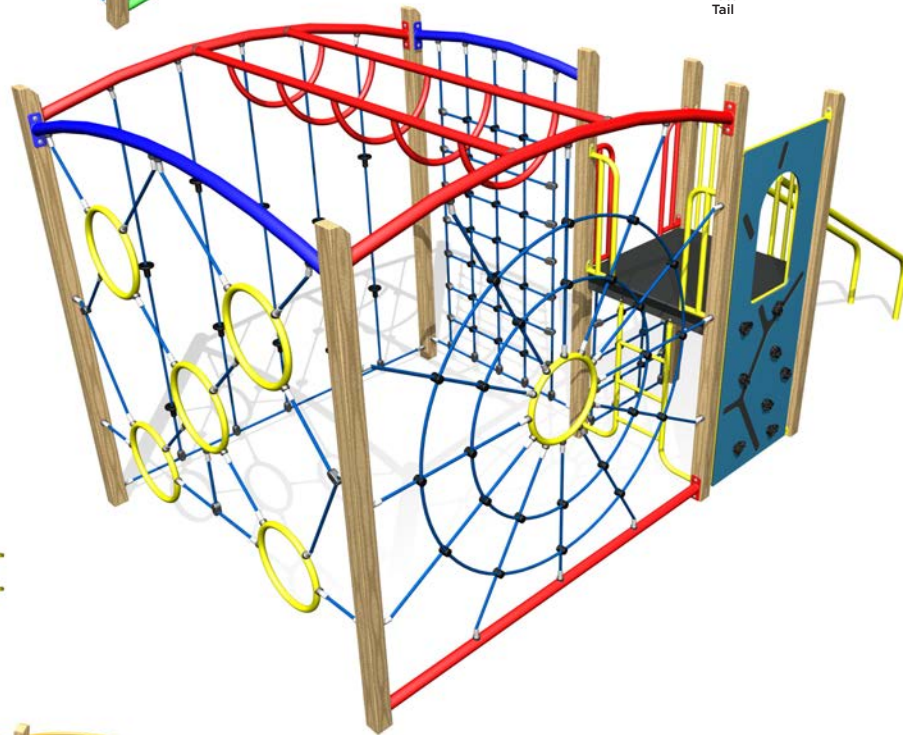

MEGA CUBE

Mega Cube FS430

Age Level: 7-15 yrs
Area Required: 9.0 x 7.5m
FHF: 2.1m
Physical Size: 3.3h x 4.6 x 3.4m
Post: Timber or Steel

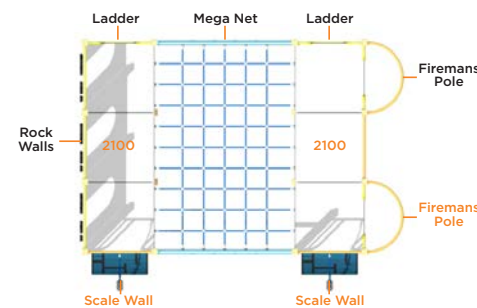

Summit

Summit FS431

Age Level: 8-15 yrs
Area Required: 9.3 x 7.2m
FHF: 2.7m
Physical Size: 3.9h x 2.6 x 4.6m
Post: Steel Only

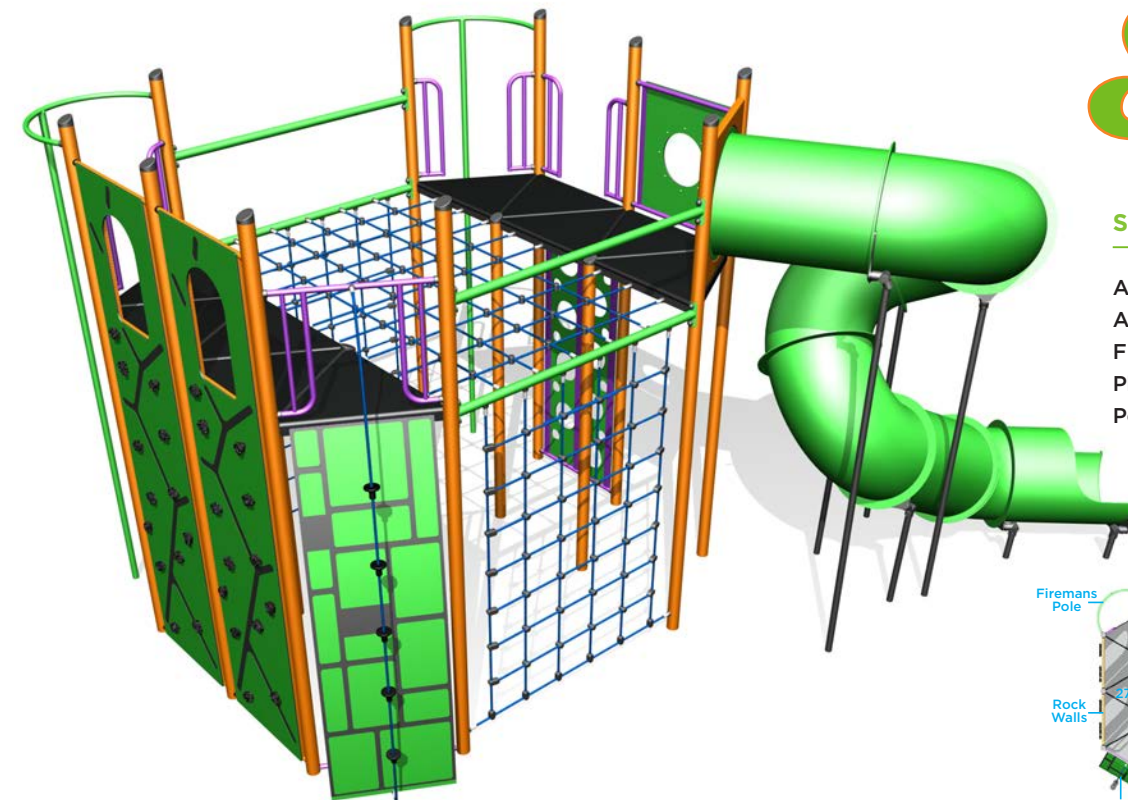
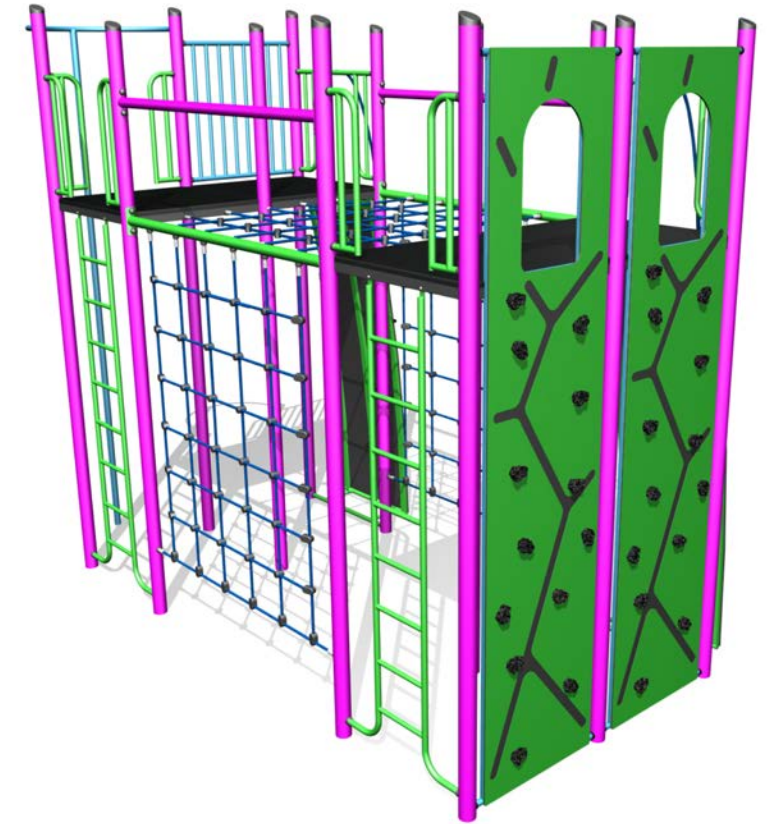
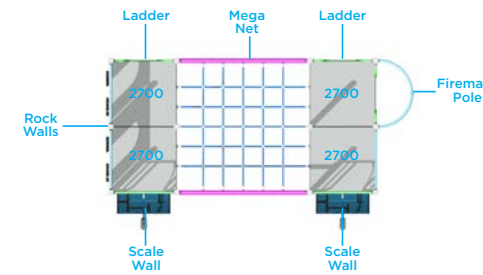

Shute

Shute FS850

Age Level: 8-15 yrs
Area Required: 8.8 x 10.6m
FHF: 2.7m
Physical Size: 3.9h x 6.9 x 5.1m
Post: Steel Only

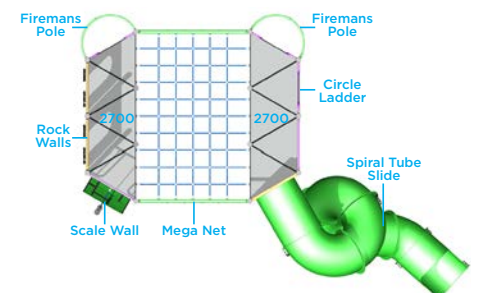



JUNIOR PLAY

Castle Play Structures



Customisable Panels



Citadel

Citadel Castle CP53

Age Level: 5-15 yrs
 Area Required: 10.3 x 6.0m
 FHF: 2.1m
 Physical Size: 3.9h x 7.3 x 3.1m
 Post: Steel Only

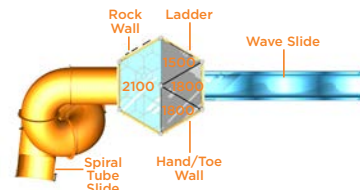

Chateau



Chateau Castle CP51

Age Level: 3-15 yrs
 Area Required: 10.6 x 7.5m
 FHF: 1.8m
 Physical Size: 3.4h x 7.7 x 4.6m
 Post: Steel Only

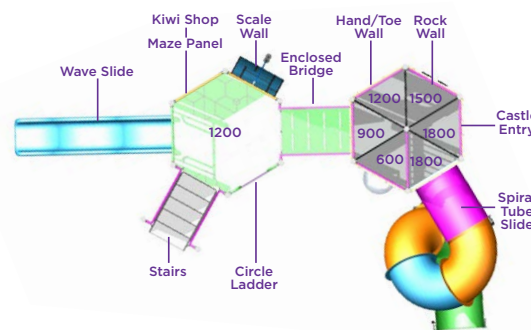

Ignite adventure, Inspire imagination, Play!



JUNIOR PLAY

Castles Play Structures



CAMELOT

Camelot Castle CP50

Age Level: 3-15 yrs
 Area Required: 16.2 x 12.1m
 FHF: 2.1m
 Physical Size: 4.0h x 11.7 x 8.1m
 Post: Steel Only

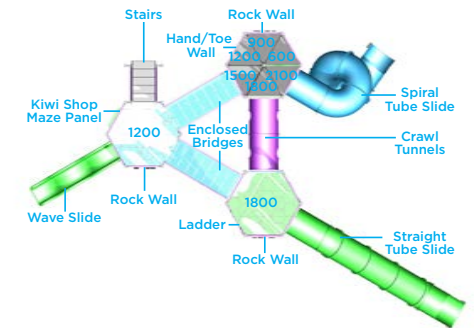

Acropolis

Acropolis Castle CP52

Age Level: 3-15 yrs
 Area Required: 14.9 x 10.2m
 FHF: 2.1m
 Physical Size: 6.0h x 12.3 x 7.6m
 Post: Timber or Steel

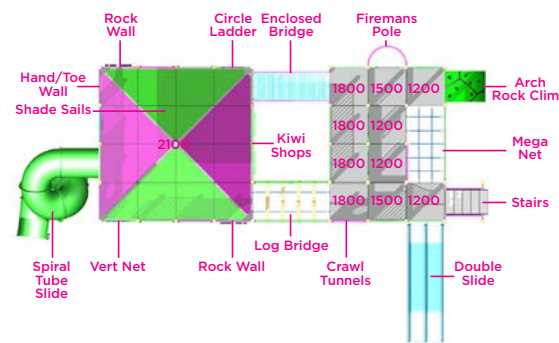



JUNIOR PLAYGROUNDS

Bastion, Tuatara and Shenanigan



JUNIOR PLAYGROUNDS

Methven and Newton



BASTION

Bastion FS846

Age Level: 5-8 yrs
 Area Required: 14.5 x 9.2m
 FHF: 1.8m
 Physical Size: 3.5h x 11.1 x 5.6m
 Post: Timber or Steel

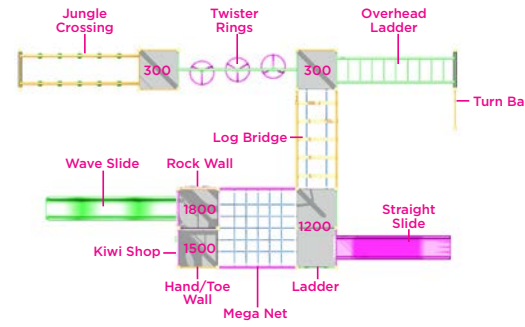

TUATARA

Tuatara FS843

Age Level: 5-12 yrs
 Area Required: 11.7 x 8.4m
 FHF: 2.1m
 Physical Size: 2.5h x 8.6 x 5.4m
 Post: Timber or Steel

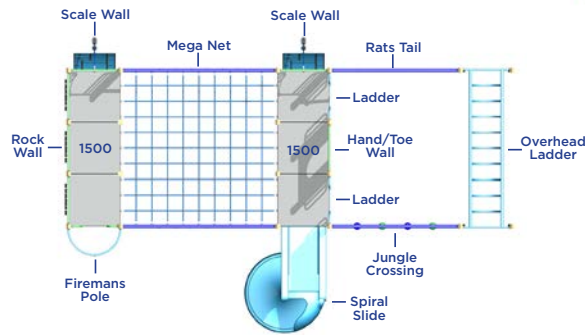
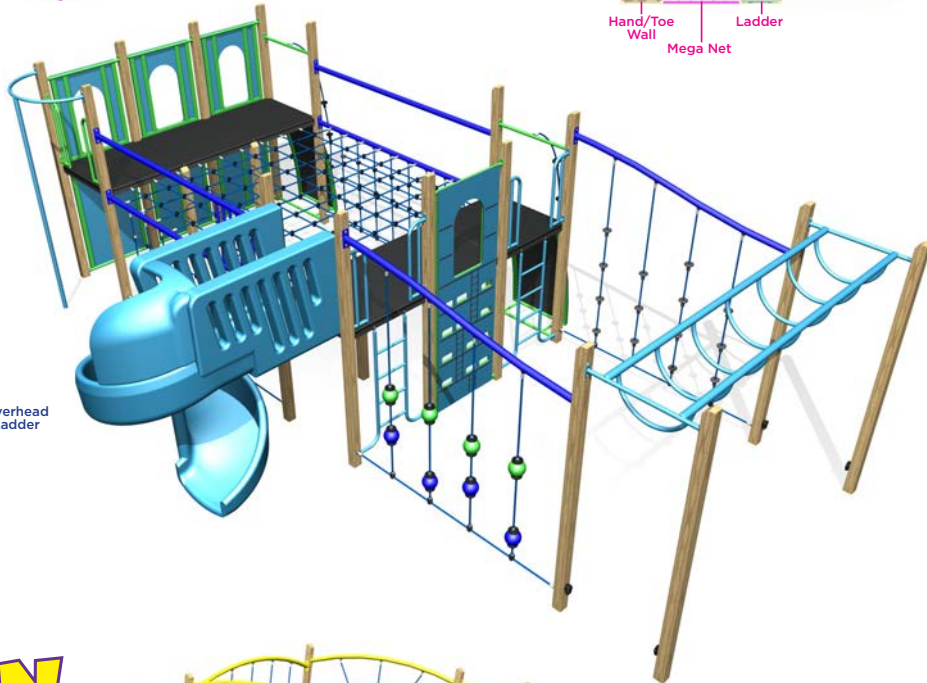

SHENANIGAN

Shenanigan FS801

Age Level: 5-12 yrs
 Area Required: 17.8 x 8.8m
 FHF: 2.7m
 Physical Size: 2.7h x 13.6 x 4.8m
 Post: Timber or Steel

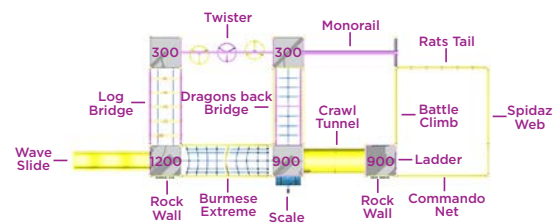

Methven

Methven FS810

Age Level: 5-12 yrs
 Area Required: 14.5 x 9.0m
 FHF: 2.7m
 Physical Size: 2.7h x 11.1 x 5.6m
 Post: Timber or Steel

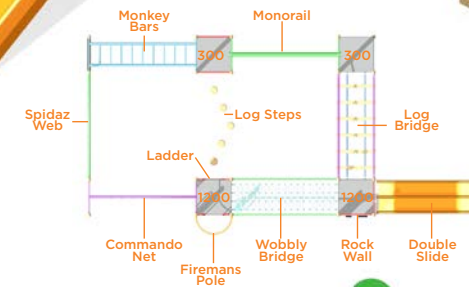
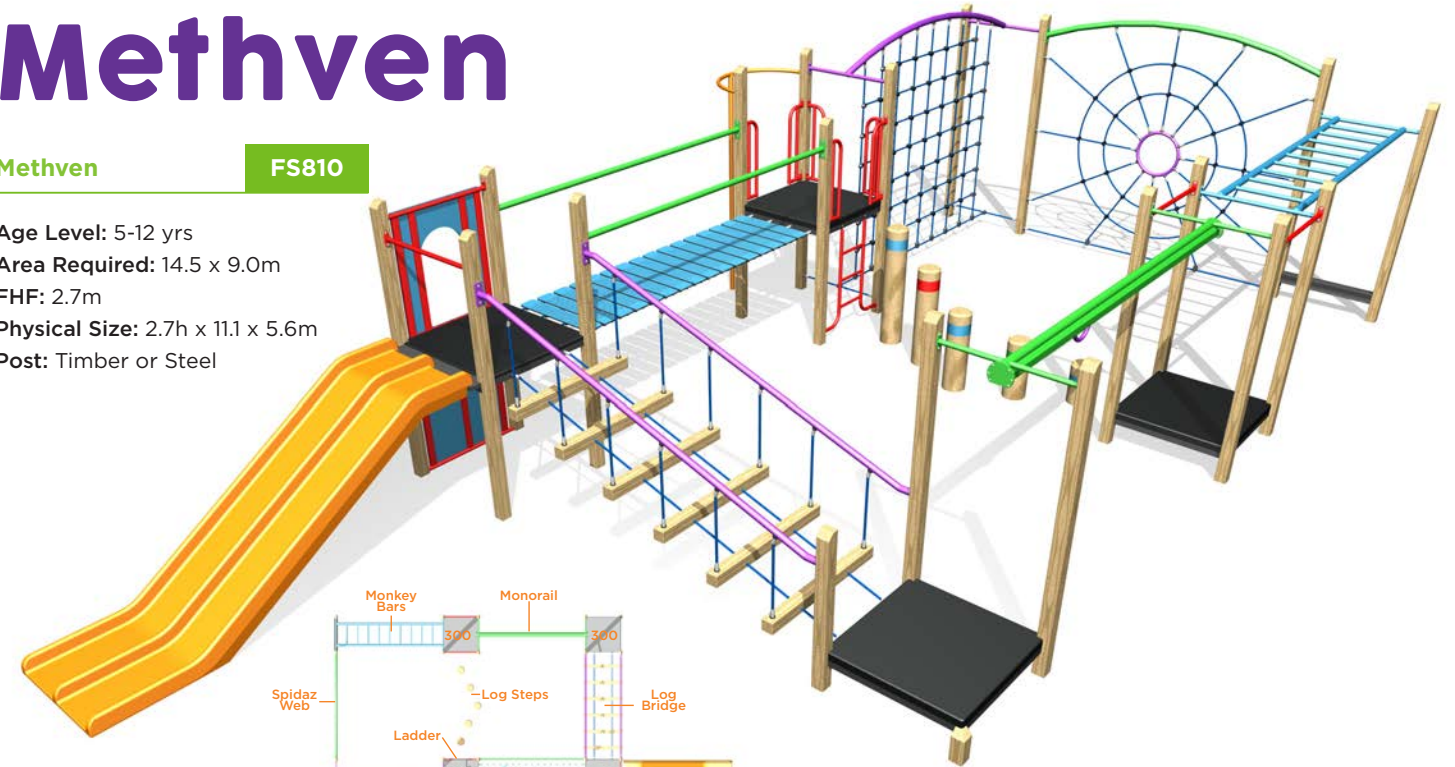

Newton

Newton FS811

Age Level: 5-12 yrs
 Area Required: 18.5 x 6.5m
 FHF: 2.1m
 Physical Size: 4.7h x 14.3 x 3.4m
 Post: Timber

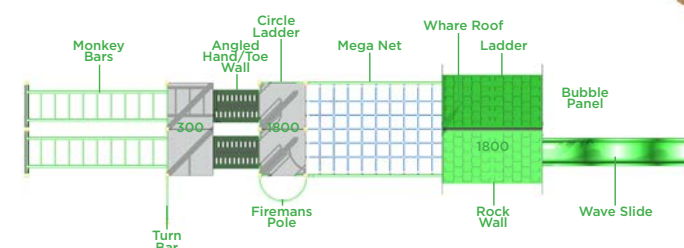



WHARE PLAY



Whare Play FS857

Age Level: 5-12 yrs
Area Required: 23.5 x 9.7m
FHF: 2.1m
Physical Size: 5.1h x 18.9 x 6.3m
Post: Timber or Steel

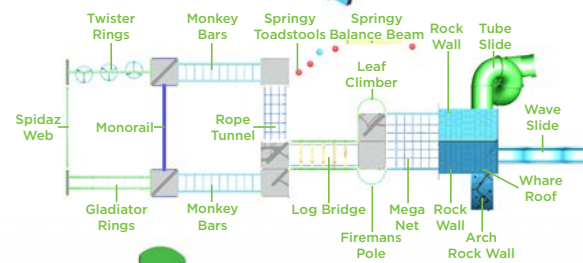

WHARE FORT



Whare Fort FS858

Age Level: 5-12 yrs
Area Required: 10.9 x 8.0m
FHF: 2.1m
Physical Size: 4.7h x 7.6 x 4.1m
Post: Timber

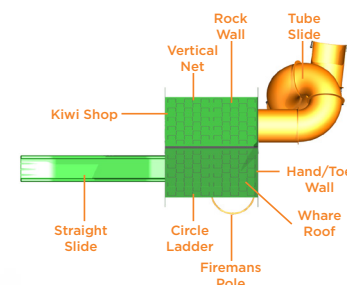

WOODSTOCK



Woodstock FS859

Age Level: 5-12 yrs
Area Required: 15.6 x 8.7m
FHF: 2.1m
Physical Size: 3.4h x 12.1 x 5.1m
Post: Timber or Steel

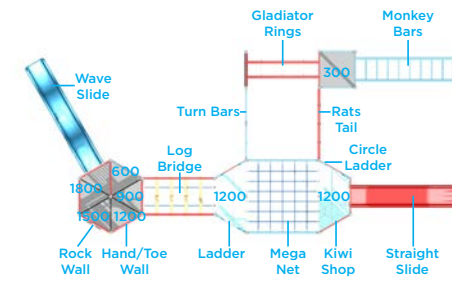

WATERLEA



Waterlea FS860

Age Level: 5-12 yrs
Area Required: 12.7 x 12.0m
FHF: 2.1m
Physical Size: 3.7h x 10.0 x 9.3m
Post: Timber or Steel

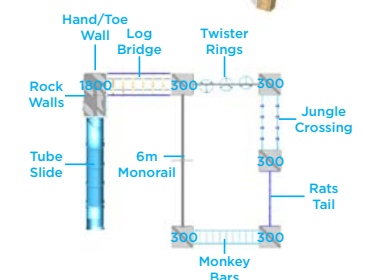



MIDDLE PLAYGROUNDS : FORTS

Matai and Fortis

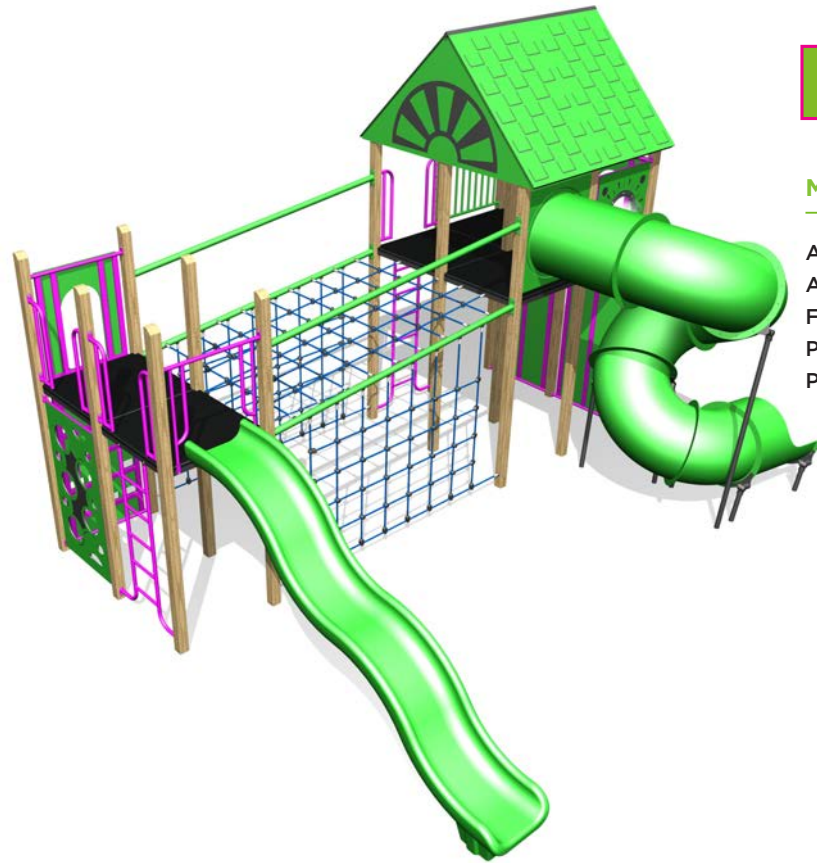

MATAI

Matai ED15

Age Level: 7-15 yrs
Area Required: 10.0 x 10.0m
FHF: 2.1m
Physical Size: 4.0h x 6.5 x 5.5m
Post: Timber or Steel

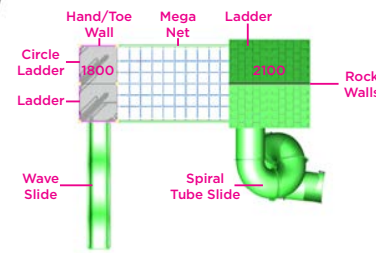

FORTIS

Fortis FS851

Age Level: 7-15 yrs
Area Required: 12.7 x 12.5m
FHF: 2.2m
Physical Size: 4.4h x 9.5 x 9.2m
Post: Timber or Steel

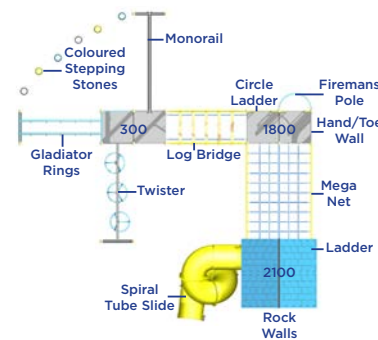

Ignite adventure, Inspire imagination, Play!



SENIOR PLAYGROUNDS : CHALLENGE

Rush and Stampede

RUSH

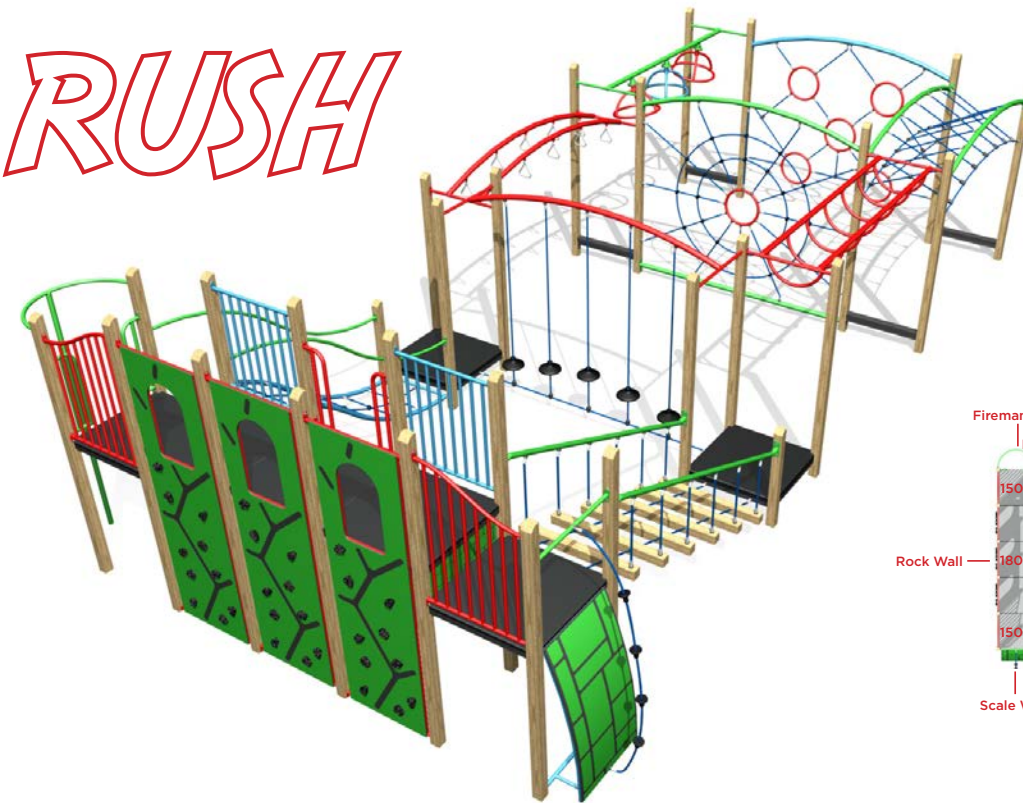

Rush FS711

Age Level: 8-15 yrs
Area Required: 15.5 x 9.0m
FHF: 2.7m
Physical Size: 2.9h x 11.1 x 5.9m
Post: Timber or Steel

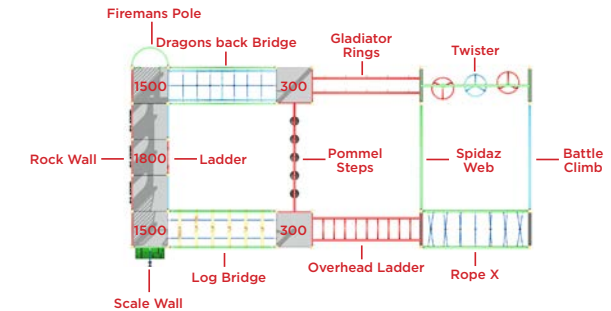

Spidaz Web



Rock Wall



Twister Rings

Stampede

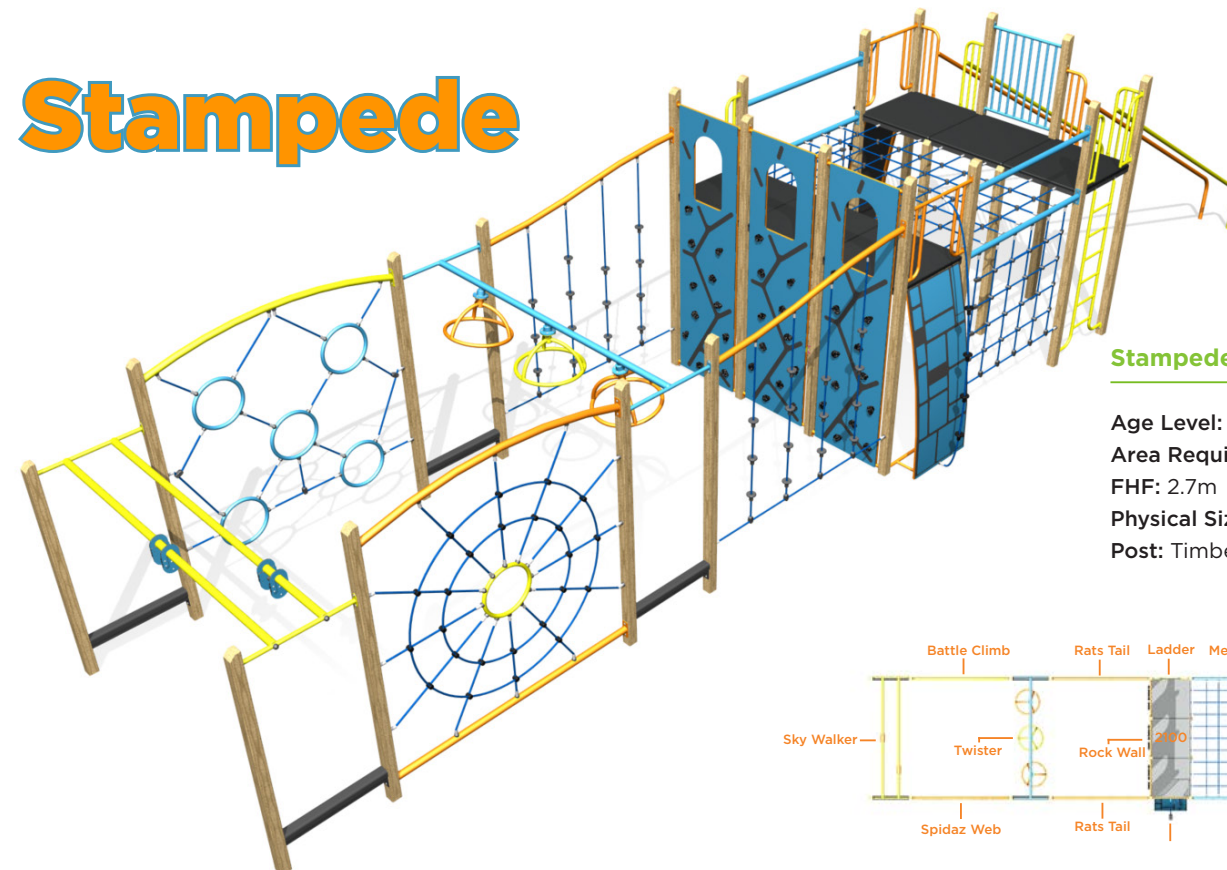

Stampede FS833

Age Level: 8-15 yrs
Area Required: 18.0 x 8.0m
FHF: 2.7m
Physical Size: 3.0h x 4.0 x 14.5m
Post: Timber or Steel

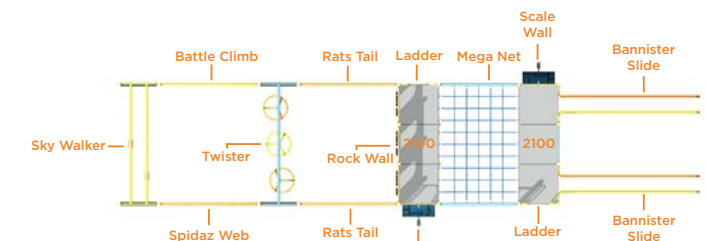



SENIOR PLAYGROUNDS : ADVENTURE

Wakaaranga and Titan

WAKAARANGA



Wakaaranga FS714

Age Level: 8-15 yrs
Area Required: 16.6 x 11.8m
FHF: 2.7m
Physical Size: 3.0h x 12.6 x 7.4m
Post: Timber or Steel

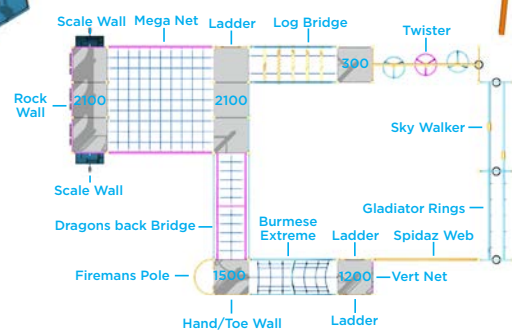

Titan FS856

Age Level: 8-16 yrs
Area Required: 15.2 x 12.0m
FHF: 2.7m
Physical Size: 3.9h x 11.6 x 7.6m
Post: Timber or Steel

TITAN

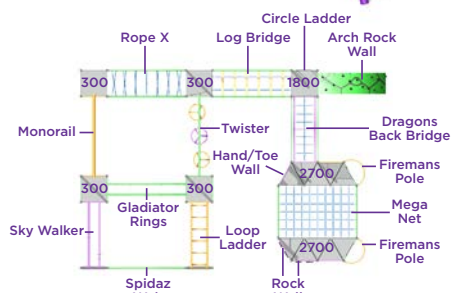
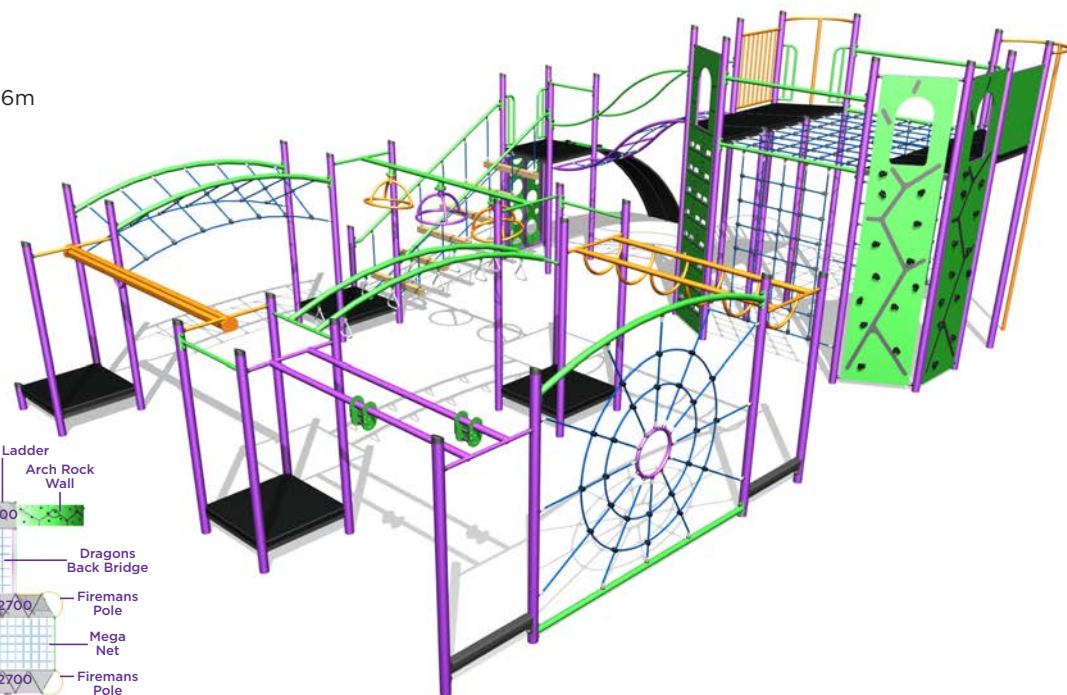

Ignite adventure, Inspire imagination, Play!



SENIOR PLAYGROUNDS : ADVENTURE

Baradeno and Behemoth

BARADENO



Baradeno FS866

Age Level: 9-15 yrs
Area Required: 18.1 x 8.1m
FHF: 2.1m
Physical Size: 3.3h x 14.6 x 4.1m
Post: Timber or Steel

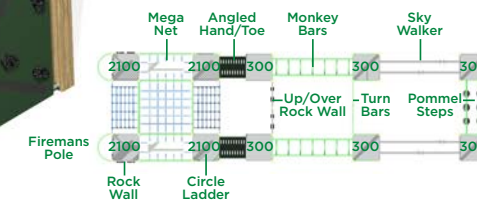

BEHEMOTH

Behemoth FS852

Age Level: 8-15 yrs
Area Required: 19.4 x 8.7m
FHF: 2.7m
Physical Size: 3.9h x 4.7 x 14.7m
Post: Timber or Steel

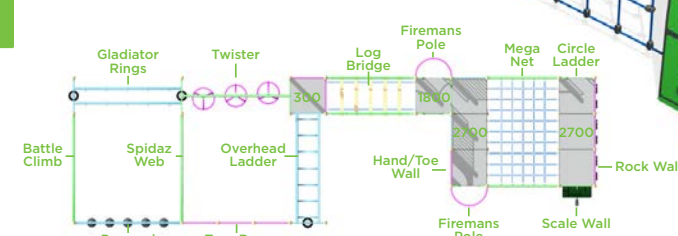



SENIOR PLAYGROUNDS : CIRCUIT

Colossus and Blitz



SENIOR PLAYGROUNDS : CIRCUIT

Mega loop

COLOSSUS

Colossus FS832

Age Level: 8-15 yrs
 Area Required: 16.0 x 16.0m
 FHF: 2.7m
 Physical Size: 3.5h x 11.8 x 11.8m
 Post: Steel only

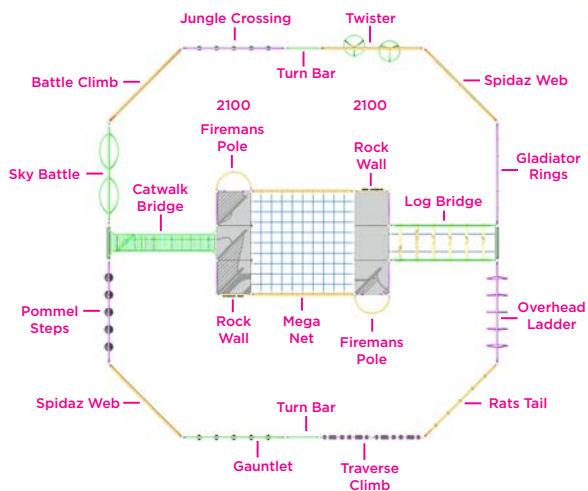
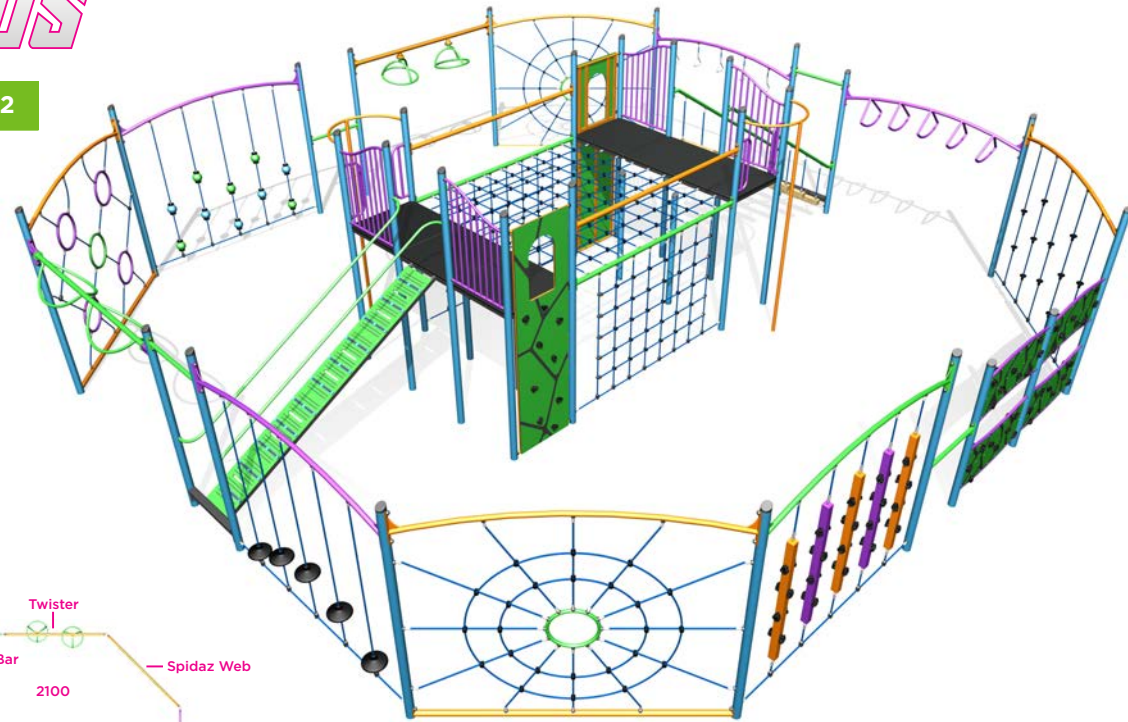

megalooop



Mega Loop FS835

Age Level: 8-15 yrs
 Area Required: 20.7 x 16.4m
 FHF: 2.7m
 Physical Size: 5.6h x 16.4 x 14.2m
 Post: Timber or Steel

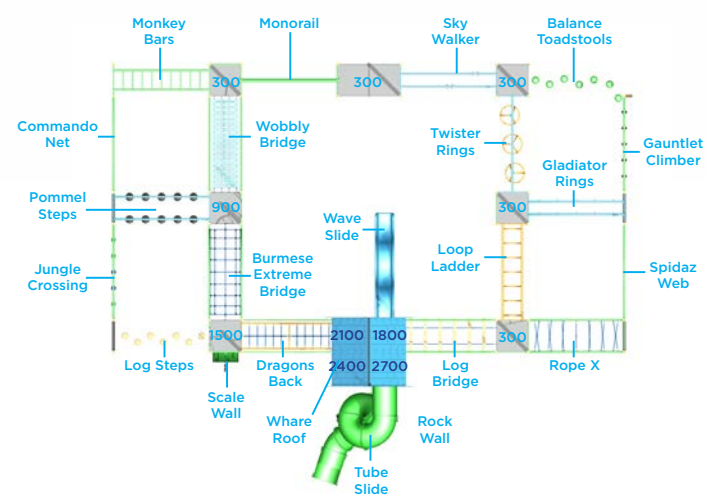

ELEVATE

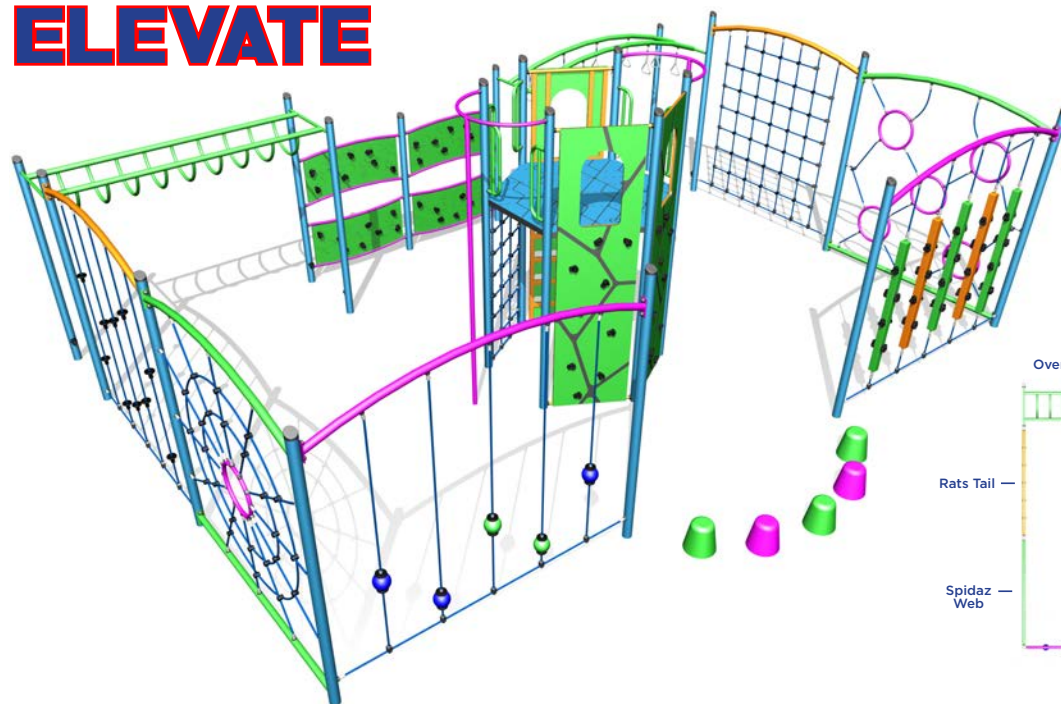

Elevate FS841

Age Level: 8-15 yrs
 Area Required: 13.7 x 10.5m
 FHF: 3.0m
 Physical Size: 3.0h x 9.1 x 7.2m
 Post: Steel only

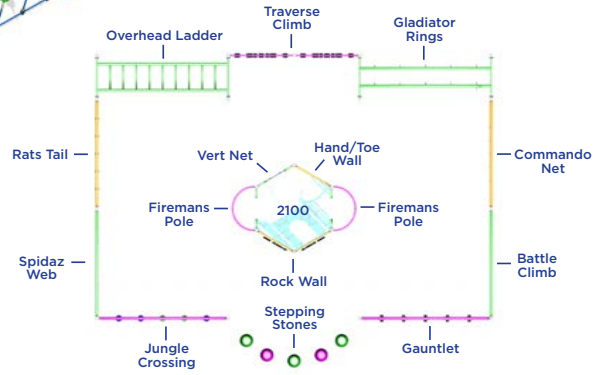

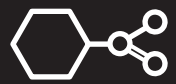

COMBOS :
Examples of playground combos



Large swing set
Scuff mats
Tube slide
Mega net
Firemans pole
Rock walls
Balance bridge
Designed into existing area

Creating play areas using odd shaped areas and incorporate play structures, dynamic elements and balance activities to make a well rounded play area is our specialty.

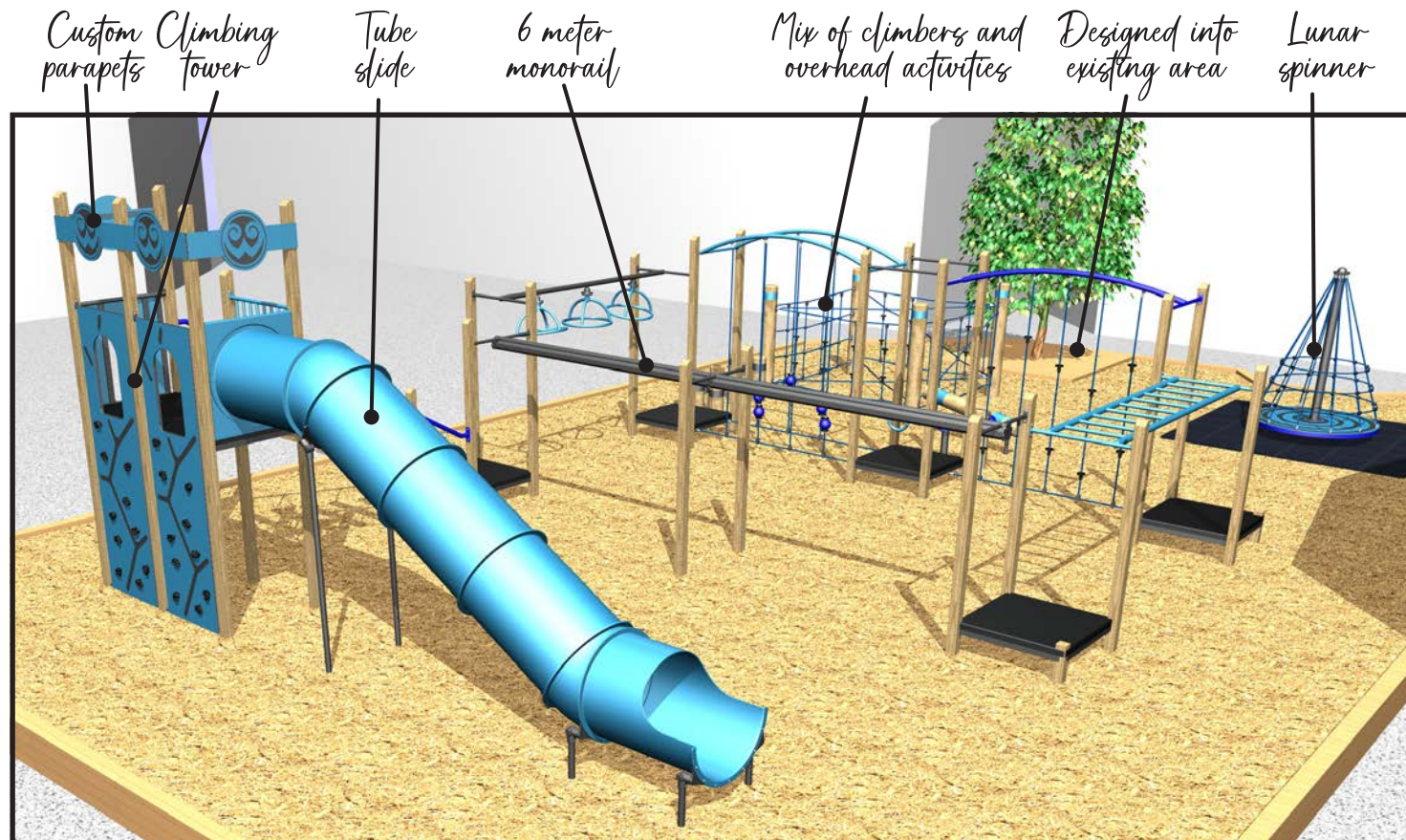

Custom parapets
Climbing tower
Tube slide
6 meter monorail
Mix of climbers and overhead activities
Designed into existing area
Lunar spinner

Ignite adventure, Inspire imagination, Play!

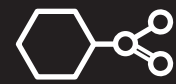

COMBOS :

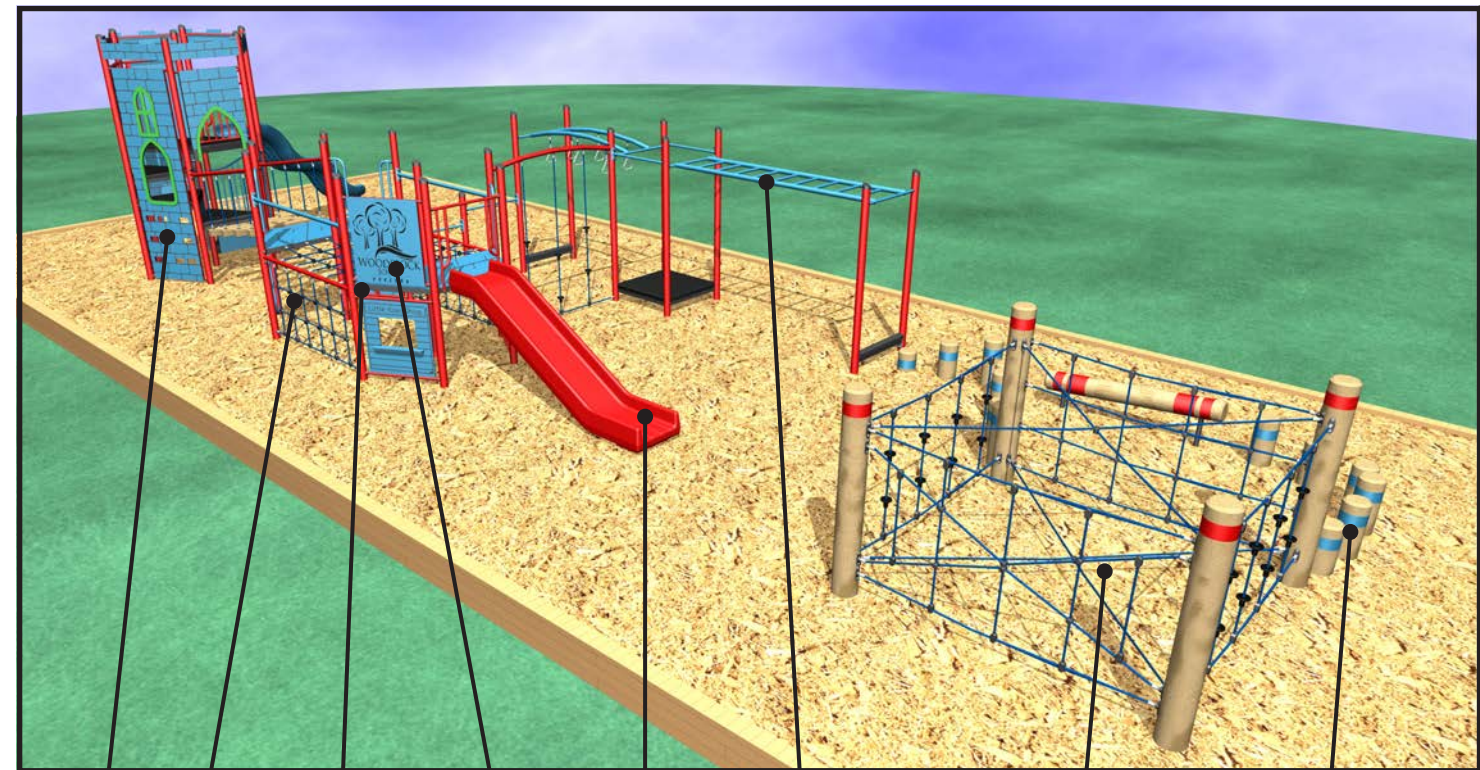

Castle theme
Climbers
Schools colours
Customised panels
Slide
Overhead activities
Rope net climbers
Balance logs

Our expert design team can take your ideas, area and budget to create a custom designed structure which includes customising panels with your schools logo or motto and combine it with play items to create a unique playground for your school.

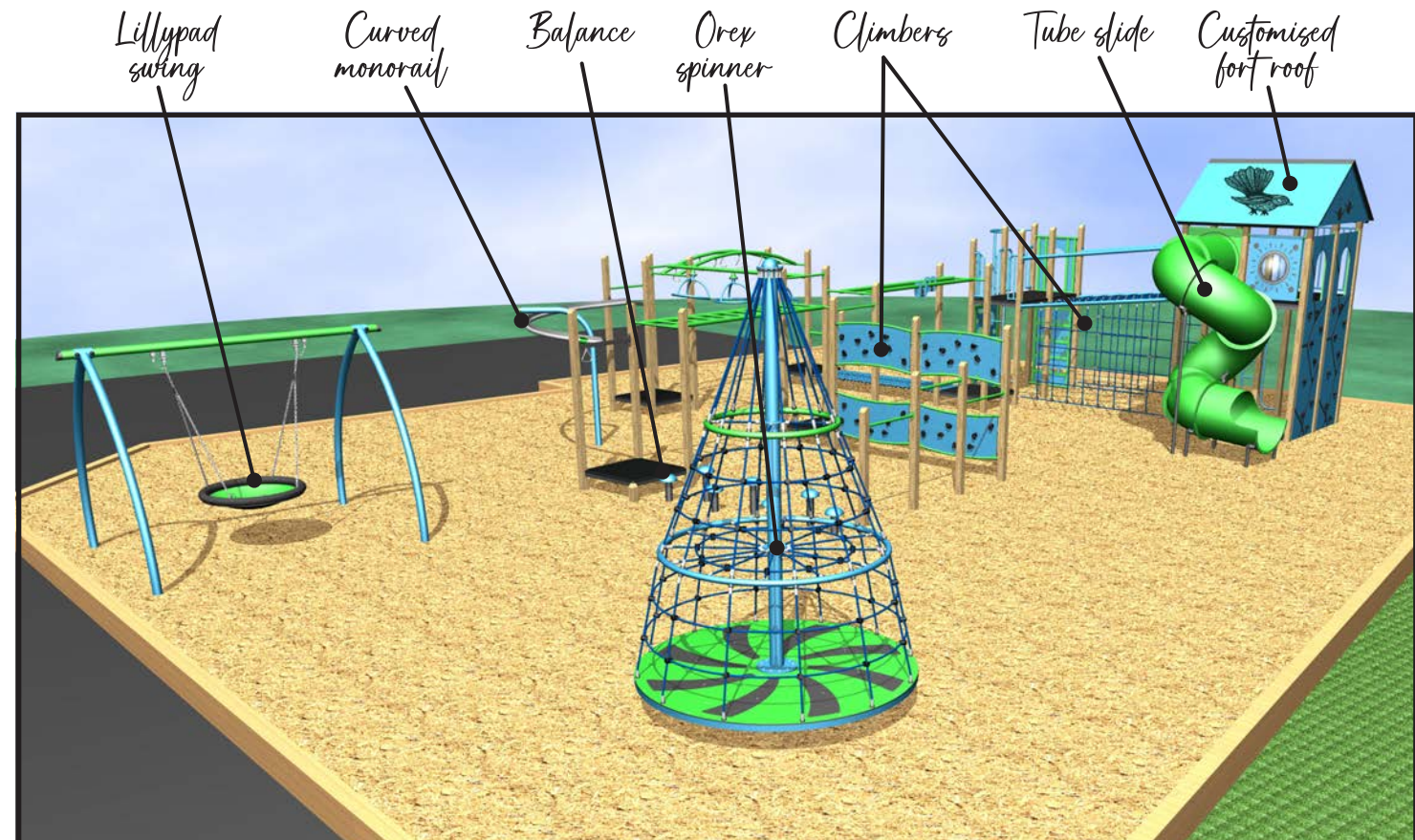

Lillypad swing
Curved monorail
Balance
Tree spinner
Climbers
Tube slide
Customised fort roof

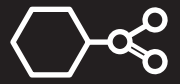

COMBOS : Loop

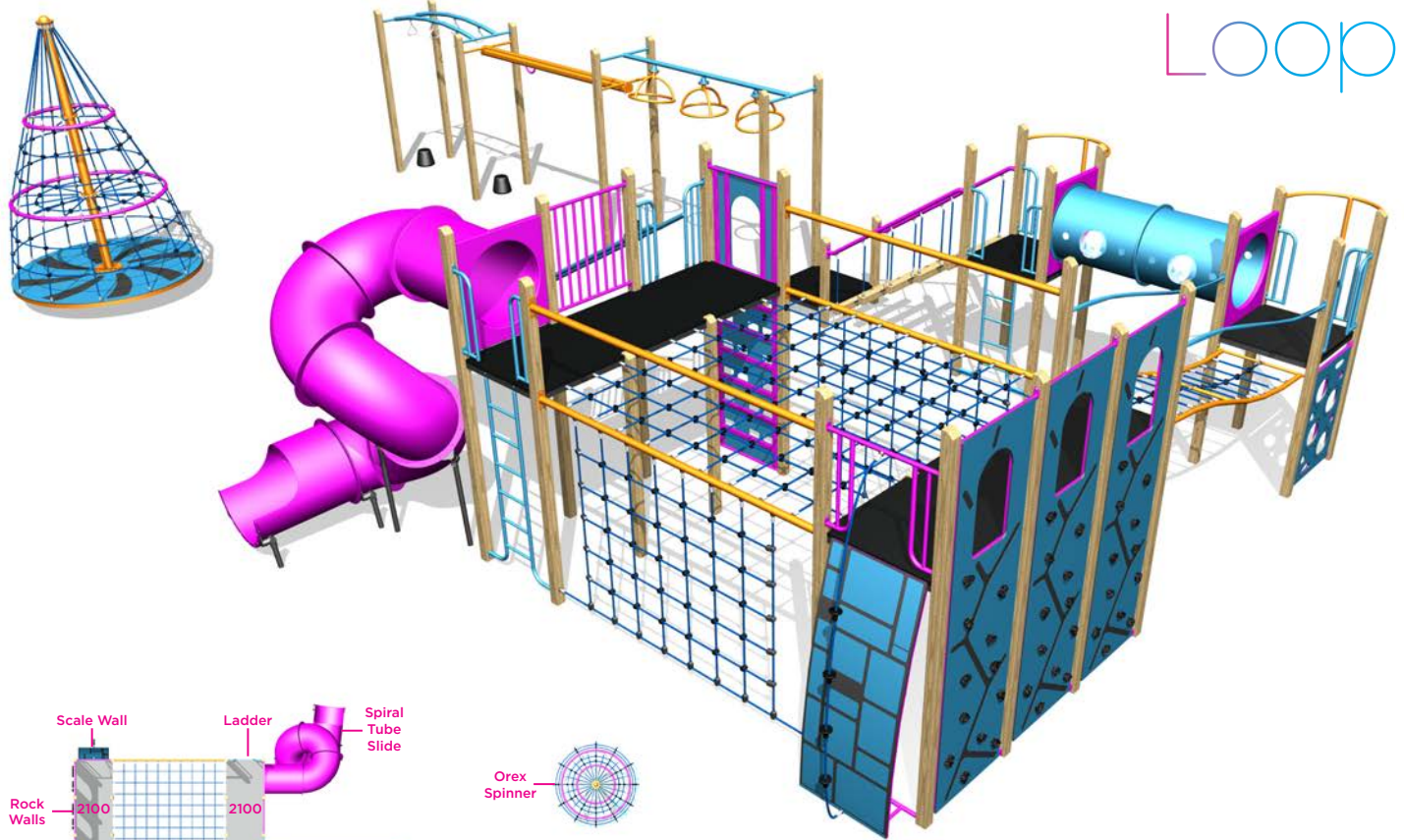

Loop

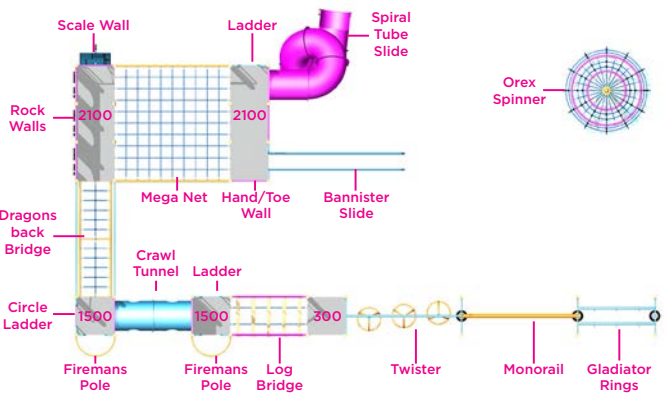

Loop **FS871**

Age Level: 8-15 yrs
Area Required: 19.0 x 12.0m
FHF: 2.7m
Physical Size: 3.5h x 9.1 x 15.1m
Post: Timber or Steel

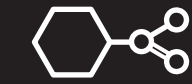
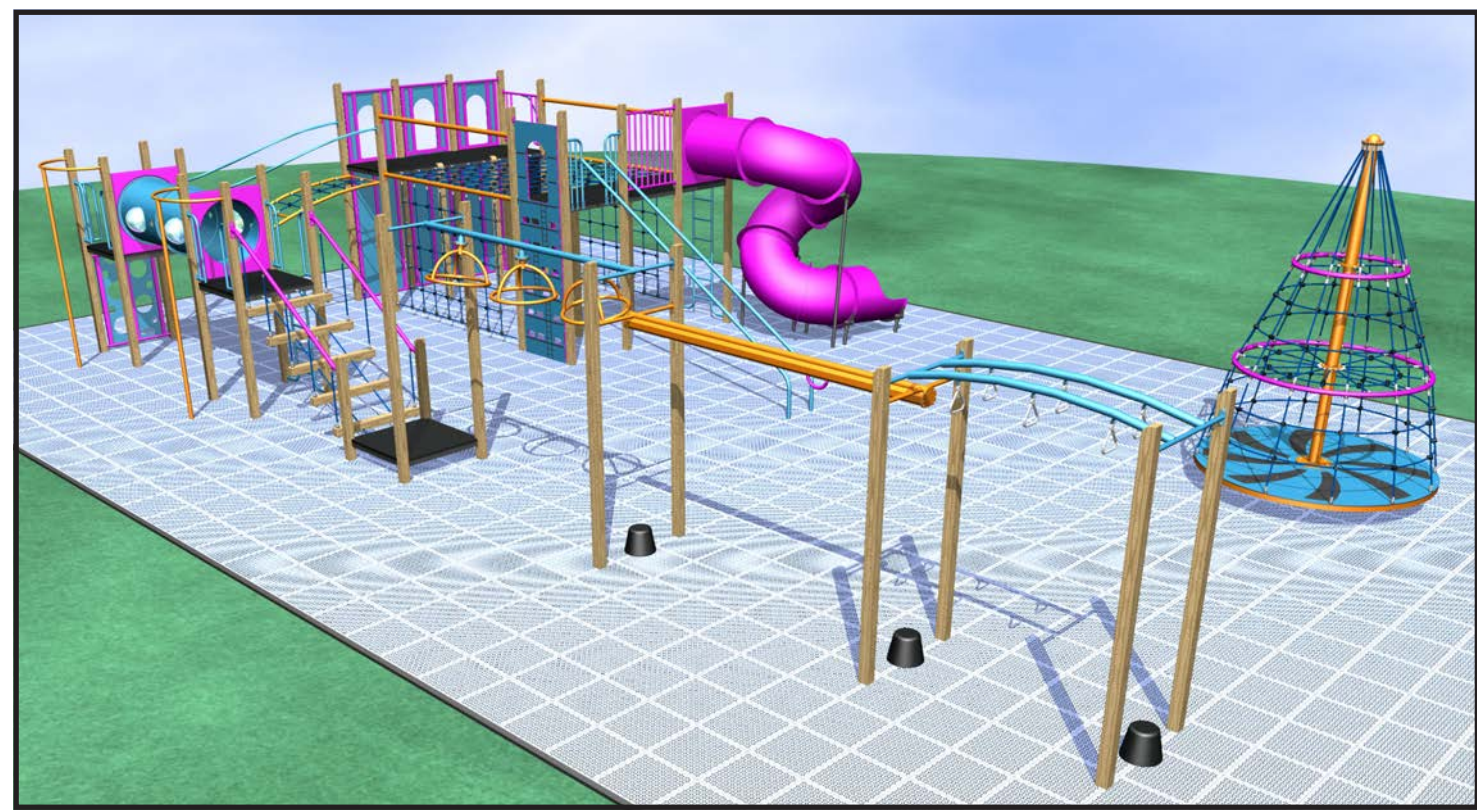

COMBOS : Revolution



Revolution

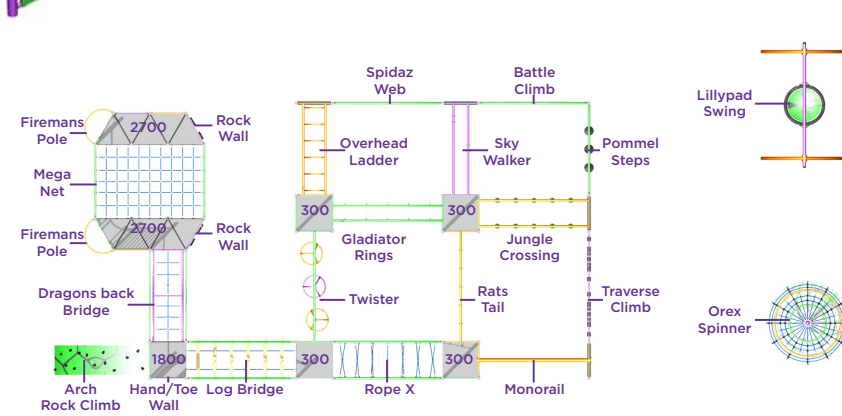

Revolution **FS870**

Age Level: 8-15 yrs
Area Required: 26.0 x 12.0m
FHF: 2.7m
Physical Size: 3.5h x 21.7 x 9m
Post: Steel only

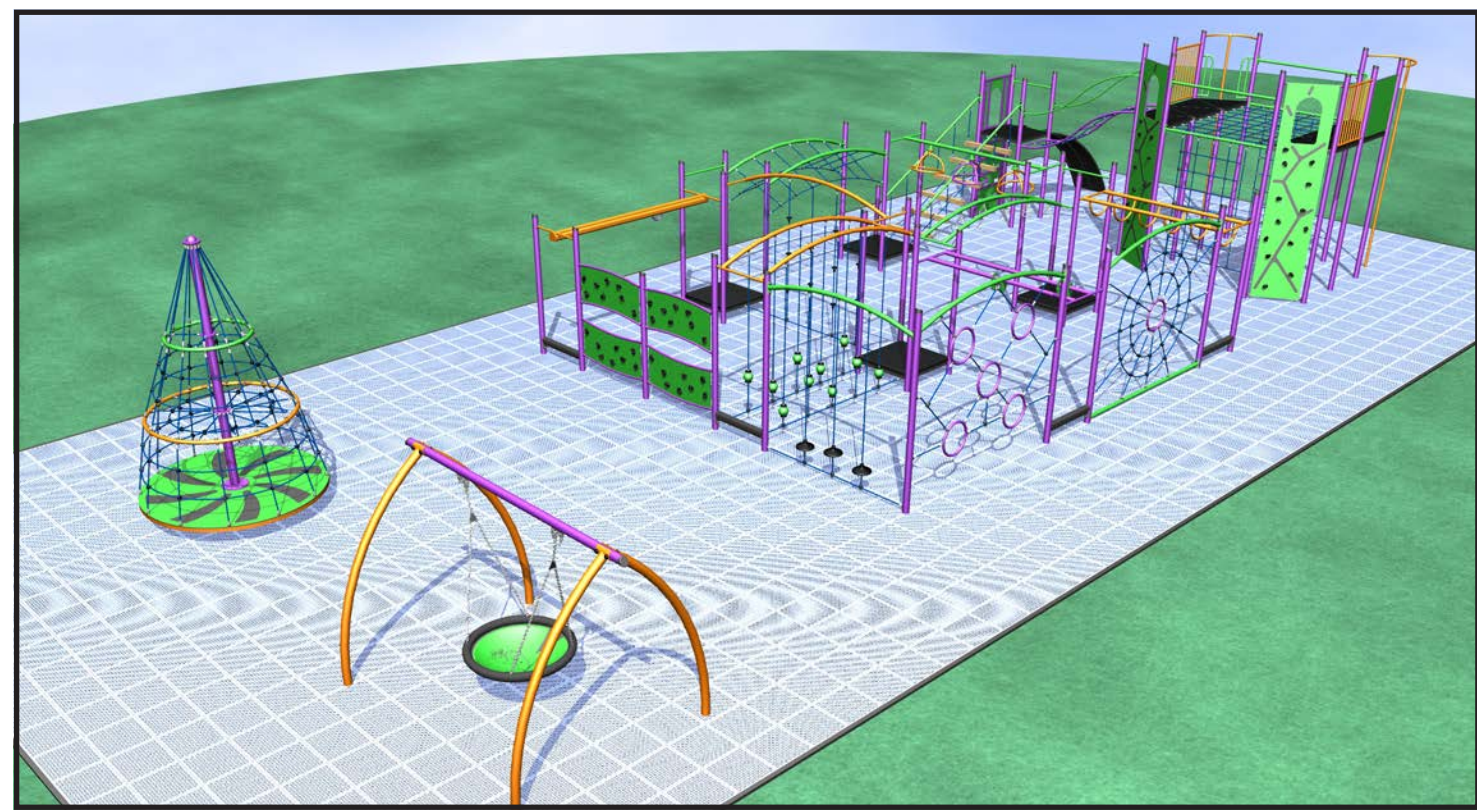



PLAYSCAPE DESIGN:



PLAYSCAPE DESIGN:

We can work with your school to create an area that incorporates play elements with planting, interesting surfacing, tactile experiences, balance, seating and themed areas to create a playspace

We aim to create:

- Open spaces for free play and socialisation with added choices for solitary play.
- Natural, appealing elements and soft scaping to encourage unwinding and relaxation.
- Subtle skill elements (balance equipment) that will help to progress and develop coordination, focus, accuracy and core control.
- Areas for imagination
- Areas of seating & relaxation
- Elements for learning spatial awareness
- A homely backyard feel to explore emotion and use their imagination
- Sensory feel



Playscapes aim to:

- Help young children to find their feet socially and emotionally as they enter into school life
- Add skill and challenge to assist their developmental needs and something for each individual imagination
- Offer activities that develop a child's core strength. Incorporating balance is essential to progress not only their core strength but also co-ordination and accuracy. Skills which can easily be transferred into the classroom
- Give options to sit and socialise or challenge their skills
- Include a variety of colours and shapes gives the extra dimension of play
- Build a great use of imaginative play while including benefits of grip strength, hand/foot co-ordination, spatial awareness, developing the vestibular system, crawling and scooting to enhance physical activity

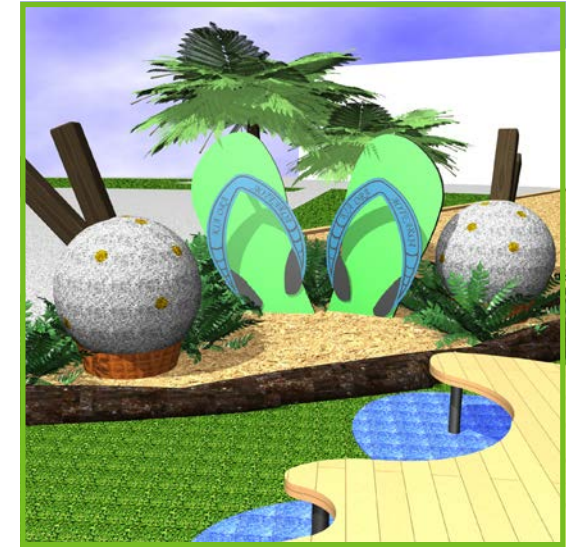



CASE STUDY: Baradene College - Senior Playground

Baradene College opened their brand new playground and for us at Park Supplies & Playgrounds, this project was something of a first.

We are renowned for the bright colours of our playgrounds which children love. Check out the new 'Nature Green' combination on the Baradene playground. The combination of the light green steel, wooden posts, nature green PolyPlay and rubber matting creates a stunning playground that blends in with the school's surroundings.

The playground is located on an unused slope, which we needed to turn into a flat surface for the playground. We were able to achieve this through the use of retaining walls. They are a reliable and trusted way of changing the landscape to suit your playground. So don't let that sloping site put you off, it can be turned into the perfect playground space.



Baradene College Playground Opening



Baradene College Playground



Orex Spinner



Climbing Activities

Ignite adventure, Inspire imagination, Play!



CASE STUDY: Matipo School



Matipo Shute Playground

MATIPO PRIMARY ADDS ADVENTURE AND PHYSICAL DEVELOPMENT TO SCHOOL PLAYGROUNDS.

Hollie Colegate has always had a passion for the community out west in Te Atatu Peninsula. It is a special place for those who live there and the community around one of their Primary Schools, Matipo Primary, has always been a highlight for Hollie.

It is this passion for fitness that led Hollie to lead the charge for the schools brand new playground.

The idea of a senior school playground focused on balance, strength, mobility, and adventure appealed to Hollie and she became the self-appointed 'application director' to the Million Dollar Mission.

With only one week until applications closed, Hollie had to move quickly to get the 3 quotations required.

Hollie said "I called around as many companies as I could to get a quote. Jenny from Park Supplies & Playgrounds was the first to come out to school and get a feel for what we wanted"

With the site visit complete and a tight turnaround required, Jenny provided Hollie with a proposal for a playground that utilised several of Park Supplies & Playgrounds pre-set designs and equipment. These included an Orex Spinner, the Shute Playground along with a series of balance and strength activities.

Fundraising for the additional money came from the community and soon Hollie was able to present the new plans for the playground to the students. They looked at the brochures and helped to finalise the plan for the playground.

With the playground now installed and kids eagerly awaiting the opportunity to play on the new playgrounds, Hollie is thrilled with the result.

And of working with Park Supplies & Playgrounds Hollie has this to say, "Jenny has been fantastic. Her enthusiasm for our playground was evident at the start and her communication throughout the process has been terrific. The guys who installed the playground were wonderful and everyone enjoyed having them onsite.

Working with Park Supplies & Playgrounds was wonderful. They were super professional, great communicators and they created solutions for us, not just answering questions. They looked for solutions with a lot of aroha."



Orex Spinner



Completed Projects

Ranui, Mangere East, St Heliers, Remuera and Green Bay School's.



Completed Projects

Pokeno, Turuturu, Mount Albert, Stanhope Road and St Kentigern Boy's School.



Ranui School



Marshall Laing School



Mangere East School



Omanaia School



Tamaoho School



Turuturu School



Mount Albert School



Whakarewarewa School



Saint Kentigern Boys' School



Papakura Central School

NEED HELP? IT'S WHAT WE ARE HERE FOR.

If you would like more information or assistance in planning your playground please get in touch with us on

0800 752 947 | www.parksupplies.co.nz

FOLLOW OUR JOURNEY ON SOCIAL MEDIA:



JENNY MULLINS

Sales Manager

021 822 676

09 527 4666

jenny@parksupplies.co.nz



MELISSA COWIE

Playground Consultant

021 502 220

09 527 4666

melissa@parksupplies.co.nz



NEW ZEALAND MADE

We manufacture our equipment right here in New Zealand. We pride ourselves on designing and manufacturing all our products in-house for NZ conditions.

FULL PROJECT MANAGEMENT

Park Supplies & Playgrounds will work with you on your project from design through to final installation, including surfacing and fencing.

REPAIRS AND MAINTENANCE

We offer a comprehensive playground repairs and maintenance service.

SAFETY

All our play equipment is designed and built in accordance with the NZS5828:2015 Safety Standard.

FUNDING

Park Supplies & Playgrounds can provide advice on how to fundraise for your playground.

PS PARK SUPPLIES & PLAYGROUNDS

Ignite adventure, Inspire imagination, Play!

